

DG

FLUGZEUGBAU GMBH



**FLIGHT MANUAL
FOR THE MOTORGLIDER
DG-1001M**

**TYPE: DG-1000
VARIANT: DG-1000M**

TC Data Sheet No.: EASA.A.072

Issued: October 2010

Owner:

Ser. No.:

Registration:



Flight manual approved by.
(Signature)
(Authority)
(Stamp)



[Handwritten signature]
25/3/11

Date of approval

This motorglider is to be operated in compliance with information and limitations contained herein.

This Flight Manual is FAA approved for U.S. registered motorgliders in accordance with the provision of 14 CFR Section 21.29, and is required by FAA Type Certificate Data Sheet No. G20CE.

Copyright DG Flugzeugbau GmbH any copy or publishing prohibited

DG Flugzeugbau
Otto Lilienthalweg 2
76646 Bruchsal
www.dg-flugzeugbau.de
Spare part- and material sales:

Telefon (07251) 3020-0
Telefax (07251) 3020-200
dg@dg-flugzeugbau.de
Tel. 07251/3020-270
lager@dg-flugzeugbau.de

Issued: October 2012

TN1000/22

Flight Manual DG-1000M

Warnings and hints

- All motorgliders are very complex technical devices. If you don't use yours as it is intended and within the certified operating limitations or if you fail to carry out proper maintenance work, it may harm your health or place your life in danger.
- Prior to flying the aircraft read all manuals carefully and regard especially all warnings, caution remarks and notes given in the manuals.
- Never take-off without executing a serious pre-flight inspection according to the flight manual!
- Always respect the relevant safety altitudes!
- Respect the stall speeds and always fly with a safety margin above the stall speed according to the flight conditions, especially at low altitudes and in the mountains.
- Use only the battery chargers as specified in the flight manual.
- Don't execute yourself any work on the control system except for greasing.
- Repairs and maintenance work should only be accomplished by the manufacturer or at certified repair stations rated for this type of work. A list of stations which have experience with DG aircraft may be obtained from DG Flugzeugbau.
In the U.S., a properly certificated individual may also perform repairs and maintenance work.
- Even if no annual inspections are required in your country, have your aircraft checked annually, see maintenance manual section 2.
- Please pay attention to our web-site www.dg-flugzeugbau.de. There you will find the latest technical notes and service information for your glider:
<http://www.dg-flugzeugbau.de/en/maintenance-service-aircraft/technical-notes>
The „DG Pilot Info“ informs you immediately by e-mail about the publication of new technical notes and service information.
If you don't receive this info service, please send a mail to goeldner@dg-flugzeugbau.de with subject "DG Newsletter please" to receive this service free of charge.

Flight Manual DG-1000M

0 Revisions

0.1 Record of revisions

Any revision of the present manual, except actual weighing data, must be recorded in the following table and in case of approved sections endorsed by the responsible airworthiness authority.

The new or amended text in the revised page will be indicated by a black vertical line in the right hand margin, and the under lying document for the revision and the date will be shown on the bottom of the page.

Rev. No.	Affected Pages/section	Description	Issue Date	EASA Approval Date	Inserted Date Signature
1	Title, 0.1, 0.2, 0.4÷0.7, 1.5, 2.5, 2.7, 2.10, 2.11, 2.13, 2.14, 3.2, 4.7, 4.9 ÷4.11, 4.14, 4.15, 4.21, 4.24, 4.29, 4.33, 5.1, 5.4 ÷ 5.12, 6.1 ÷ 6.3, 6.5, 6.7, 6.9 ÷ 6.15, 7.2, 7.6, 7.9, 7.12, 7.25 ÷ 7.28, 7.30, 8.3	Manual revision TN1000/22	October 2012	10. Dec. 2012	
2	0.2, 0.4 ÷ 0.6, 2.5, 2.6, 4.33, 7.19, 7.30	Manual revision TN1000/23	July 2014	7 August 2014	
3	0.2, 0.4, 0.5, 4.15	Manual revision TN1000/27	July 2015	10. August 2015	
4	0.1, 0.2, 0.4-0.6, 2.14, 4.10, 4.11, 4.12, 4.16, 6.6, 7.2, 7.30	Manual revision TN1000/32	July 2017	10.08.2017	

Flight Manual DG-1000M

Page intentionally left blank

Flight Manual DG-1000M

0.2 List of effective pages

Section	page	issued	replaced	replaced	
0	Title	October 2010	October 2012		
	0.1	see manual amendments			
	0.2	"			
	0.3	"			
	0.4	"			
	0.5	"			
	0.6	"			
	0.7	"			
	0.8	October 2010			
1	1.1	October 2010			
	1.2	March 2011			
	1.3	October 2010			
	1.4	October 2010			
	1.5	October 2010	October 2012		
	1.6	October 2010			
2	EASA-app.	2.1	October 2010		
	"	2.2	October 2010		
	"	2.3	October 2010		
	"	2.4	October 2010		
	"	2.5	October 2010	October 2012	July 2014
	"	2.6	October 2010		July 2014
	"	2.7	October 2010	October 2012	
	"	2.8	October 2010		
	"	2.9	October 2010		
	"	2.10	October 2010	October 2012	
	"	2.11	October 2010	October 2012	
	"	2.12	October 2010		
	"	2.13	October 2010	October 2012	
	"	2.14	October 2010	October 2012	July 2017
3	"	3.1	October 2010		
	"	3.2	October 2010	October 2012	
	"	3.3	October 2010		
	"	3.4	October 2010		
	"	3.5	October 2010		
	"	3.6	October 2010		
	"	3.7	October 2010		
	"	3.8	October 2010		

Flight Manual DG-1000M

0.2 List of effective pages (cont.)

Section		page	issued	replaced	
4	EASA-app.	4.1	October 2010		
	"	4.2	October 2010		
	"	4.3	October 2010		
	"	4.4	October 2010		
	"	4.5	October 2010		
4		4.6	October 2010		
		4.7	October 2010	October 2012	
	"	4.8	October 2010		
	"	4.9	October 2010	October 2012	
	"	4.10	October 2010	October 2012	July 2017
	"	4.11	October 2010	October 2012	July 2017
	"	4.12	October 2010	July 2017	
	"	4.13	October 2010		
	"	4.14	October 2010	October 2012	
	"	4.15	October 2010	October 2012	July 2015
	"	4.16	October 2010	July 2017	
	"	4.17	October 2010		
	"	4.18	October 2010		
	"	4.19	October 2010		
	"	4.20	October 2010		
	"	4.21	October 2010	October 2012	
	"	4.22	October 2010		
	"	4.23	October 2010		
	"	4.24	October 2010	October 2012	
	"	4.25	October 2010		
	"	4.26	October 2010		
	"	4.27	October 2010		
	"	4.28	October 2010		
	"	4.29	October 2010	October 2012	
	"	4.30	October 2010		
	"	4.31	October 2010		
	"	4.32	October 2010		
	"	4.33	October 2010	October 2012	July 2014
5	"	5.1	October 2010	October 2012	
	"	5.2	October 2010		
	"	5.3	October 2010		
	"	5.4	October 2010	October 2012	
	"	5.5	October 2010	October 2012	
	"	5.6	October 2010	October 2012	
	EASA-app.	5.7	October 2010	October 2012	
		5.8	October 2010	October 2012	
		5.9	October 2010	October 2012	
		5.10	October 2010	October 2012	
		5.11	October 2012		
		5.12	October 2012		

Flight Manual DG-1000M

0.2 List of effective pages (cont.)

Section	page	issued	replaced	Section
6	6.1	October 2010	October 2012	
	6.2	October 2010	October 2012	
	6.3	October 2010	October 2012	
	6.4	October 2010		
	6.5	October 2010	October 2012	
	6.6	October 2010	July 2017	
	6.7	October 2010	October 2012	
	6.8	October 2010		
	6.9	October 2010	October 2012	
	6.10	October 2010	October 2012	
	6.11	October 2010	October 2012	
	6.12	October 2010	October 2012	
	6.13	October 2012		
	6.14	October 2012		
	6.15	October 2012		
7	7.1	October 2010		
	7.2	October 2010	October 2012	July 2017
	7.3	October 2010		
	7.4	October 2010		
	7.5	October 2010		
	7.6	October 2010	October 2012	
	7.7	October 2010		
	7.8	October 2010		
	7.9	October 2010	October 2012	
	7.10	October 2010		
	7.11	October 2010		
	7.12	October 2010	October 2012	
	7.13	October 2010		
	7.14	October 2010		
	7.15	October 2010		
	7.16	October 2010		
	7.17	October 2010		
	7.18	October 2010		
	7.19	October 2010	July 2014	
	7.20	October 2010		
	7.21	October 2010		
	7.22	October 2010		
	7.23	October 2010		
	7.24	October 2010		
	7.25	October 2010	October 2012	
	7.26	October 2010		
	7.27	October 2010	October 2012	
	7.28	October 2010	October 2012	
	7.29	October 2010		
	7.30	October 2010	October 2012 July 2017	July 2014

Flight Manual DG-1000M

0.2 List of effective pages (cont.)

Section	page	issued	replaced	Section
8	8.1	October 2010		
	8.2	October 2010		
	8.3	October 2010	October 2012	
	8.4	October 2010		
	8.5	October 2010		
	8.6	October 2010		
	8.7	October 2010		
	8.8	October 2010		
9	9.1	October 2010		
	9.2	October 2010		
	9.3	October 2010		

Flight Manual DG-1000M

0.3 Table of contents

	Section
General (a non-approved section)	1
Limitations (an approved section)	2
Emergency procedures (an approved section)	3
Normal procedures (an approved section)	4
Performance (a partly approved section)	5
Mass (weight) and balance (a non-approved section)	6
Motorglider and systems description (a non-approved section)	7
Motorglider handling, care and maintenance (a non-approved section)	8
Supplements	9

Flight Manual DG-1000M

1 General

Section	page
1.1 Introduction	1.2
1.2 Certification basis.....	1.2
1.3 Warnings, cautions and notes.....	1.3
1.4 Descriptive data.....	1.4
1.5 Three view drawing (dimensions in mm)	1.6

Flight Manual DG-1000M

1.1 Introduction

The motorglider flight manual has been prepared to provide pilots and instructors with information for the safe and efficient operation of the DG-1000M motorglider.

This manual includes the material required to be furnished to the pilot by JAR Part 22. It also contains supplemental data supplied by the glider manufacturer.

1.2 Certification basis

This type of motorglider variant DG-1000M has been approved by the EASA in accordance with:

Airworthiness requirements:

JAR Part 22 „*Sailplanes and powered sailplanes*“, amendment 6, issued 1. August 2001.

EASA type certification date for variant DG-1000M: 17. March 2011

The amended Type Certificate EASA.A.072 has been issued on 23. March 2011.

Category of Airworthiness: "Utility"

1.3 Warnings, cautions and notes

The following definitions apply to warnings, cautions and notes used in the flight manual.

- | | |
|------------------|---|
| "Warning" | means that the non observation of the corresponding procedure leads to an immediate or important degradation of the flight safety. |
| "Caution" | means that the non observation of the corresponding procedure leads to a minor or to a more or less long term degradation of the flight safety. |
| "Note" | draws the attention on any special item not directly related to safety but which is important or unusual. |

1.4 Descriptive data

The DG-1000M is a self-launching two-place high performance motorglider with retractable powerplant for training and cross country flying.

- Wing constructed from carbonfibre reinforced plastics with parting at y= 8,6m and wing tips for 20 m span with Winglets.
- Automatic hook-ups for all controls.
- Comfortable seating and modern cockpit design similar to the DG-single-seaters - safety cockpit.
- Large 2 piece canopy for very good in-flight vision.
- Draught free canopy demist and 1 adjustable swivel air vent for each pilot.
- Sealed airbrake and landing gear boxes.
- Controls in each cockpit.
- All controls are operated with the left hand, which enables the right hand to remain on the control stick.
- Very high, spring-mounted, electrically operated retractable main landing gear, wheel with hydraulic disc brake.
A landing gear warning device is integrated into the system.
Both cockpits are equipped with all controls and control lights.
A manually operated emergency extension system is provided.
Technical data:
Extension and retraction time (electrically operated): approx. 7seconds
Extension time emergency operation: approx. 2 seconds.
- Steerable tailwheel and wing wheels for easy taxiing. The wing wheels are mounted only approx 8.5 m outboard of the fuselage centre to allow taxiing on narrow taxiways.

Other characteristics:

- Water ballast bags in the wings are optional.
- Standard: A ballast-box is installed in the fin. It can be used to compensate for the mass of the rear pilot and as trim-possibility for heavy pilots.
- Max. ballast capacity: 12 kg.
- Option: 2 ballast boxes in the front cockpit. The trim-weights used for the trim-ballast box in the fin also fit into these ballast boxes.

Flight Manual DG-1000M

Powerplant and powerplant controls:

- Retractable powerplant with liquid-cooled Solo 2 625 02 i two stroke engine with electronic fuel injection and Composite propeller.
The engine is mounted flexibly to the propeller mast for vibration insulation.
Reduction gear with 5 high-tech V-belts.
The engine is equipped with an emergency system which may be activated via a switch in the front (and optionally in the rear) instrument panel in case of a failure of the engine control unit (ECU). This system ensures uninterrupted engine operation during take-off and climb.
Battery ignition with normal and emergency system.
- Electrical engine extension-retraction, operated automatically with the ignition switch or manually as back-up, electronic safety devices to avoid incorrect operation.
- Engine control instruments with digital LCD indication (Microprocessor technology) DEI-NT including stall warning, outside air thermometer, landing gear warning and canopy warning.

Technical data

Wingspan	m / ft	20 / 65.62
Wing surface	m ² / ft ²	17.53 / 189
Aspect ratio	/	22.82
Length	m / ft	8.57 / 28.12
Fuselage height	m / ft	1.0 / 3.28
Fuselage width	m / ft	0.73 / 2.4
Horizontal tailplane span	m / ft	3.2 / 10.5
Waterballast (optional)	kg (l) / US.gal	160 / 42.3
Empty mass with basic instruments approx.*	kg / lbs	530 / 1168
Wing loading (with 80kg payload) approx.	kg/m ² / lbs/ft ²	34.8 / 7.13
Max. mass	kg / lbs	790 / 1742
Max. wing loading	kg/m ² / lbs/ft ²	45 / 9.22
Max. speed	km/h / kts	270 / 146
Certified for aerobatics	Category U, simple aerobatics approved up to a max. mass of 683 kg /1506 lbs.	

Powerplant

Engine	Solo 2 625 02 i two-cylinder-two-stroke-engine with electronic fuel injection	
Power	50 KW / 68 hp	
Reduction gear	approx. 1:2.8	
Fuel tank capacity	40 Liter	
Propeller	BM-G1-160-R-120-1	Composite
Propeller diameter	1.6 m / 5.25	

*Options will increase the empty mass accordingly!

1.5 Three view drawing (dimensions in mm)

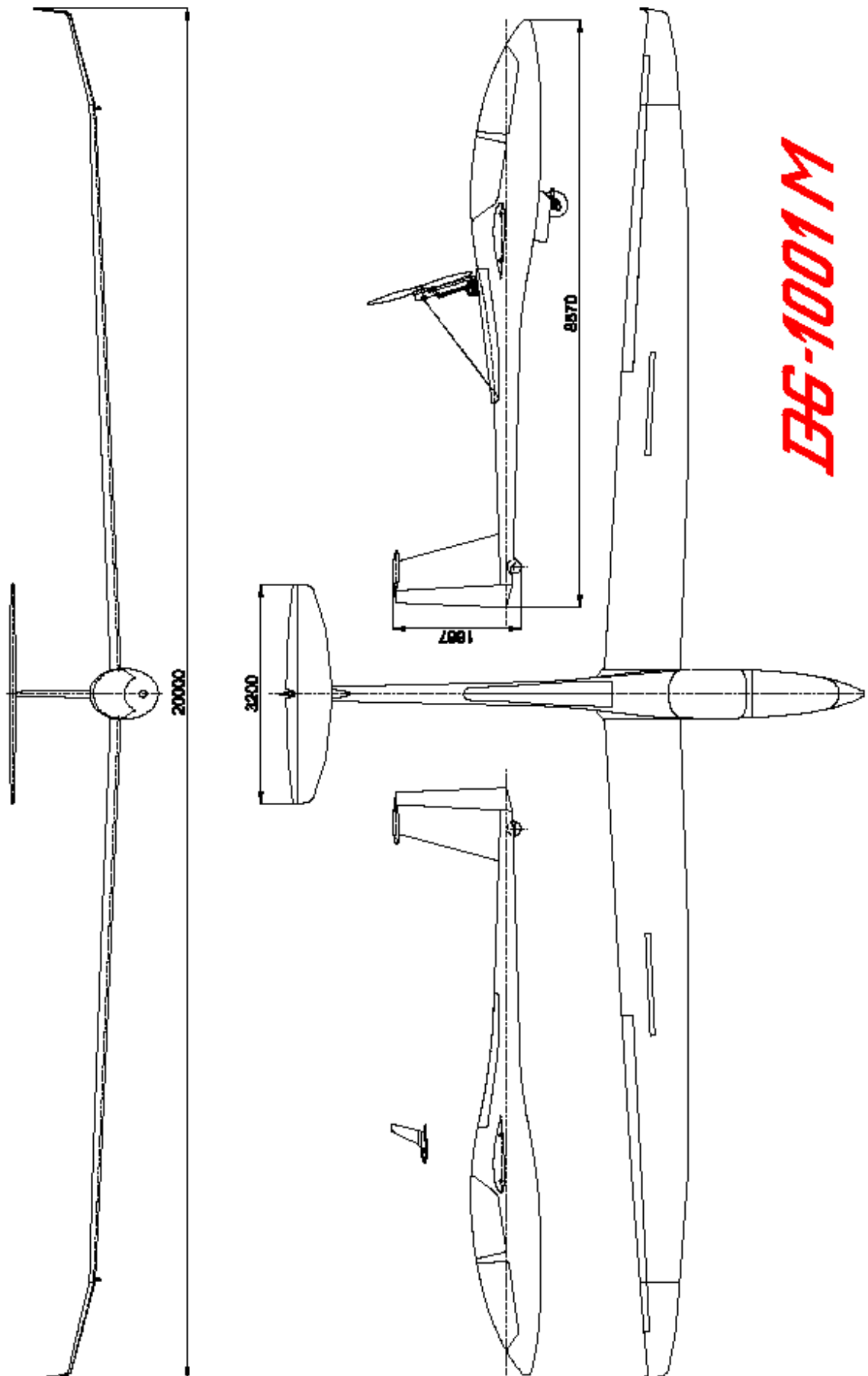

Flight Manual DG-1000M

2 Limitations

Section	page
2.1 Introduction	2.2
2.2 Airspeed	2.3
2.3 Airspeed Indicator Markings.....	2.4
2.4 Power plant.....	2.5
2.5 Power plant instrument markings	2.5
2.6 Fuel.....	2.6
2.7 Mass (weight).....	2.7
2.8 Centre of gravity.....	2.8
2.8.1 Centre of gravity for operation with powerplant installed.....	2.8
2.8.2 Centre of gravity for operation with powerplant removed	2.8
2.9 Approved manoeuvres	2.8
2.10 Manoeuvring load factors	2.9
2.11 Flight crew.....	2.9
2.12 Kinds of operation.....	2.10
2.13 Minimum equipment.....	2.11
2.14 Aerotow, winch and autotow launching	2.12
2.14.1 Weak links in towing cables	2.12
2.14.2 Towing cables (for aerotow only)	2.12
2.14.3 Max. towing speeds.....	2.12
2.14.4 Tow Release	2.12
2.15 Crosswinds	2.12
2.16 Tyre Pressure.....	2.12
2.17 Waterballast (Option).....	2.13
2.18 Trim ballast box in the fin.....	2.13
2.19 Other limitations.....	2.13
2.19.1 Approach and landing	2.13
2.20 Limitations placards	2.14

Flight Manual DG-1000M

2.1 Introduction

Section 2 includes operating limitations, instrument markings and basic placards necessary for safe operation of the motorglider, its standard systems and standard equipment.

The limitations included in this section have been approved by the EASA.

Flight Manual DG-1000M

2.2 Airspeed

Airspeed limitations and their operational significance are shown below

	Speed	IAS km/h (kts.)	Remarks
VNE	Never exceed speed	270 (146)	Do not exceed this speed in any operation and do not use more than 1/3 of control deflection.
VPE	Max. speed with powerplant extended	185 (100)	Do not exceed this speed with the powerplant extended (engine idling)
VRA	Rough air speed	185 (100)	Do not exceed this speed except in smooth air and then only with caution. Rough air is in lee-wave rotors, thunderclouds, visible whirlwinds or over mountain crests etc.
VA	Manoeuvring speed	185 (100)	Do not make full or abrupt control movement above this speed, because under certain conditions the motorglider may be overstressed by full control movement.
VW	Maximum winch-launching speed	150 (81)	Do not exceed this speed during winch- or auto-tow-launching
VT	Maximum aero-towing speed	185 (100)	Do not exceed this speed during aerotowing.
VLO	Maximum landing gear operating speed	185 (100)	Do not extend or retract the landing gear above this speed.
VPO	Max. speed to extend and re-tract the power-plant	100 (54)	Do not extend or retract the powerplant above this speed
VLE	Never exceed speed in case the landing gear is not locked	150 (81)	Do not exceed this speed in case the landing gear is not locked, see emergency procedures sect. 3.14

Warning: If the landing gear is operated at speeds higher than VLO and if gusts generate accelerations higher than 4 g the landing gear may be damaged.

Flight Manual DG-1000M

Warning: At higher altitudes the true airspeed is higher than the indicated airspeed, so V_{NE} is reduced with altitude according to the table below, see also section 4.5.11.

Altitude in [m]	0-3000	4000	5000	6000	7000	8000
V_{NE} indicated km/h	270	256	243	230	217	205

Altitude in [ft]	0-10000	13000	16000	20000	23000	26000
V_{NE} indicated kts.	146	138	131	124	117	111

2.3 Airspeed Indicator Markings

Airspeed indicator markings and their colour code significance are shown below.

Marking	(IAS) value or range km/h (kts)	Significance
Green Arc	90 – 185 (48.6 – 100)	Normal operating range (Lower limit is the speed $1.1 \cdot V_{S1}$ with maximum mass and most forward C.G. Upper limit is the maximum rough air airspeed.)
Yellow Arc	185 – 270 (100 – 146)	Manoeuvres must be conducted with caution and only in smooth air.
Red Line	270 (146)	Maximum speed for all operations
Blue line	95 (51.3)	Speed of best climb V_y
Yellow triangle	105 (56.7)	Approach speed at maximum weight without water ballast

Flight Manual DG-1000M

2.4 Power plant

Engine	Solo Kleinmotoren	
manufacturer:	Sindelfingen/Maichingen Germany	
Engine	Solo 2 625 02 i, liquid cooled two cylinder two stroke engine	
Maximum	Start:	50 KW / 68 PS (horse power)
power:	Continuous:	50 KW / 68 PS
Max.	Engine RPM:	6600 1/min
"	Continuous RPM:	6600 1/min
Max. cylinderhead (coolant) temperature:	105°C	
Reduction gear (with 5 V-belts)	approx. 1:2,8	

Caution: The engine is equipped with an emergency system which may be activated via a switch in the front (and optionally in the rear) instrument panel in case of a failure of the engine control unit (ECU). This system ensures uninterrupted engine operation.

Note: The engine control (ECU) prevents exceeding an engine RPM of 6700 by switching off the ignition. If you reduce the engine speed the ignition will be activated again.

Note: The max. engine RPM given by the engine manufacturer is 6700 RPM. This max. RPM is reduced for operation in the DG-1000M for not exceeding the max. permissible RPM of the propeller.

Propeller:	Diameter 1.6 m (5.25 ft)
Manufacturer:	Binder Flugzeug und Motorenbau GmbH
Type /Variant:	BM-G1-160-R-120-1

2.5 Power plant instrument markings

(on DEI-NT, DEI=digital engine indicator)

Power plant instrument markings and their significance are shown below:

Engine speed indicator:

At the centre of the DEI-NT display, digital indication with 4 digits, limitation data printed above display:

green	0-6600	normal operation range RPM
red	6600	max. RPM

Max. continuous RPM:

No indication as identical with max. RPM.

Max. RPM:

When exceeding this RPM a full screen warning message “Engine Speed” appears, when this warning has been confirmed (by pushing the selector knob at the right hand side of the display) the engine speed display is blinking whilst the engine speed is above max. RPM..

Flight Manual DG-1000M

Cylinderhead (coolant) temperature indicator (CHT):

On right hand upper side of the DEI-NT display, digital indication with 3 digits, limitation data printed above display:

red 95°C up to ser. No. 10-204M22,
105°C from ser. No. 10-205M23 on and earlier ser. No.s if
instruction 3 from TN1000/23 has been executed.

When exceeding this temperature a full screen warning “CHT overTemp” appears, when this warning has been confirmed (by pushing the selector knob at the right hand side of the display) the CHT display will keep blinking as long as the CHT is above the max. CHT.

Fuel quantity indicator:

On left hand upper side of the DEI-NT display, indication digital with 2 digits. Limitation data for the non useable amount of fuel printed above the display:

red 1 L

When a fuel quantity of approx. 4 Litres is reached a full screen warning “Low Fuel” appears, when this warning has been confirmed (by pushing the selector knob at the right hand side of the display) “R” is displayed and blinking.

2.6 Fuel

Fuel capacity:

Fuselage tank:

total:	41 L	(10.83 US gal.)
Non useable amount of fuel:	1 L	(0.26 US gal.)
Useable amount of fuel:	40 L	(10.57 US gal.)

Approved fuel grades:

Car super gasoline min. 95 octane (ROZ) (RON) leaded or unleaded

or: AVGAS 100 LL (only if super gasoline is not available)

or: mix 50% AVGAS 100 LL and 50% Car super gasoline unleaded min
92 octane (ROZ) (RON)

Caution: Fuel with more than 10% Ethanol is not acceptable to be used for the DG-1000M engine.

mixed with self mixing Super quality two stroke oil - specification JASO FC or FD or higher quality. Mixing ratio 1:50.

Note: The SOLO company recommends the following oil types: CASTROL Actevo 2T or CASTROL Super TwoStroke.

Flight Manual DG-1000M

2.7 Mass (weight)

Category „Utility“:

with water ballast:

Maximum take and landing off mass: 790 kg (1742 lbs.)

Caution: It is recommended to dump the water ballast before landing on airfields. Always dump the ballast before an outlanding.

without water ballast: Maximum take-off and landing mass = $W_{NLP} +$

W_{wings}

W_{NLP} = Maximum mass of the non lifting parts (see below)

W_{wings} = actual mass of the wings

Maximum mass of the non lifting parts = 600 kg (1323 lbs.)

Maximum mass in baggage compartment: 15 kg (33 lbs.)

Caution: Heavy pieces of baggage must be secured to the baggage compartment floor (screwing to the floor or with belts). The max. mass secured on one half of the floor (left and right of fuselage centre line) should not exceed 7,5kg (16.5 lbs.).

Ballast

1. Maximum waterballast: 160 kg (353 lbs.)

2. Maximum mass in the trim-ballast box in the fin: 12 kg (26.5 lbs.)

3. Maximum mass in the trim-ballast boxes in the front cockpit (Option): 5 kg (11 lbs.) per box, total 10 kg. (22 lbs.)

With this ballast the max. take-off mass is not to be exceeded.

Caution: Follow the loading procedures see section 6.

2.8 Centre of gravity

2.8.1 Centre of gravity for operation with powerplant installed

Centre of gravity range in flight with powerplant installed is:

320mm (12.6 inch) up to 440mm (17.32 inch) behind datum.

Datum = wing leading edge at the root rib.

Horizontal reference line = aft fuselage centre line horizontal.

Empty mass C.G. diagram powerplant installed see sect. 6.8.9.1.

Warning: To keep from exceeding the forward C.G. limits when flying the DG-1000M two-seated, heavy pilots must compensate the mass of the front and the rear pilot according to section 6.8.7.

It is strongly recommended to perform a C.G. calculation according to section 6.9. For this calculation use the pilot C.G.'s marked with "v"

2.8.2 Centre of gravity for operation with powerplant removed

Centre of gravity range in flight with powerplant removed is:

200mm (7.87 inch) up to 440mm (17.32 inch) behind datum.

Empty mass C.G. diagram powerplant removed see sect. 6.8.9.2.

To keep from exceeding the forward C.G. limits when flying the DG-1000M two-seated with powerplant removed, heavy pilots need **not** necessarily compensate the mass of the front and the rear pilot according to section 6.8.7.2..

2.9 Approved manoeuvres

Category „Utility“:

The glider is certified for normal gliding in the "Utility" category.

Simple aerobatics are approved but only up to a max. mass of 683 kg /1506 lbs (single seated or with 2 light pilots) and with the weight of the rear pilot compensated by ballast in the ballast box in the fin see section 6.8.9.

The following aerobatic manoeuvres are approved:

Spins	Chandelle
Inside loop	Turn
Lazy Eight	

Recommended entry speeds see section 4.5.16.

Warning: No aerobatic manoeuvres are allowed during extension and retraction of the landing gear or if flying with the landing gear unlocked (see emergency procedures sect. 3.14).

Flight Manual DG-1000M

2.10 Manoeuvring load factors

The following load factors must not be exceeded:

	max. speed	Load factor	
		pos.	neg.
at manoeuvring speed	V_A	+5,3	-2,65
at max. speed	V_{NE}	+4,0	-1,5
with airbrakes extended	V_{NE}	+3,5	0
operating the landing gear	VLO	+4	-2,65
in case the landing gear is not locked	VLE	+4	-2,65

2.11 Flight crew

- a) Single seated, only permissible in the front seat

max. load in the front seat

110 kg (242 lbs.)

min. load in the front seat

see placard in cockpit and weighing report page 6.7

- b) Two seated

Either the front seat or the rear seat may be designated as seat of the pilot in command.

If the rear seat is to be designated it must be assured that all necessary operating items and instruments are installed and that the pilot in command has sufficient training in flying safely from the rear seat.

Max. cockpit load is 210 kg (463 lbs.) with a max. of 105 kg (231 lbs.) in the front seat or 110 kg (242 lbs.) in the front seat and 90 kg (198 lbs.) in the rear seat.

Min. cockpit load in the front seat is the min. cockpit load (see a)) minus 40% of the load in the rear seat. This means that 10 kg (22 lbs.) in the rear seat replaces 4 kg (8.8 lbs.) missing cockpit load in the front seat.

With these loads, the C.G. given under section 2.8 will be kept within limits if the empty weight C.G. is in its limits, and if, with max. two seated cockpit load, 12 kg ballast are loaded in the fin ballast box, see warning in section 2.8.

Flight Manual DG-1000M

Caution: With lower pilot weights lead ballast must be added to the seat. Ballast placed on the seat (lead ballast cushion) must be fastened at the safety belt anchor point.

Option: Provision for removable trim-ballast in the front cockpit see sect 7.17.1.

Note: For Australia the lower limit for the min. load in the cockpit should not exceed 66 kg (146 lbs.). A provision for removable ballast see sect. 7.17.1 is mandatory.

2.12 Kinds of operation

1. Flights according to VFR (daylight)
2. Self launching
3. Aerotow
4. Winch- and auto-launching

In addition

1. Cloud flying (daylight): permitted when properly instrumented (see section 2.13b).
2. Simple aerobatics see sect. 4.5.16 "Category „Utility“"

Warning: Simple aerobatics and cloud flying are approved up to a max. mass of 683 kg /1506 lbs, which means single seated or with 2 light pilots

Note: Cloud flying is not permitted in Canada and Australia.

Note for the US: "Cloud Flying" is considered flying in Instrument Meteorological Conditions (IMC) and requires an Instrument Flight Rules (IFR) clearance in the U.S. This is permissible in the U.S. provided the pilot has the appropriate rating per 14 CFR 61.3, the glider contains the necessary equipment specified under 14 CFR 91.205, and the pilot complies with IFR requirements.

2.13 Minimum equipment

As minimum equipment only the instruments and equipment specified in the equipment list (see maintenance manual) are admissible.

Note: The actual equipment list is attached to the maintenance manual.

a) Normal operation

Airspeed indicator Range: 0-300 km/h (0-165kts.);

Speed range markings see sect. 2.3

Altimeter Range: 0 – min. 10.000 m

(for altimeter in imperial units min. 20000 ft.)

Altimeter with fine range pointer, 1 turn max. 1000 m (3000 ft.)

Magnetic compass (compensated in the aircraft)

Four piece symmetrical safety harnesses

VHF - transceiver (ready for operation)

Engine speed indicator, Fuel quantity indicator, Cylinder head (coolant) temperature indicator, Engine elapsed time indicator (counts as long as the engine is running):

These 4 indicators are incorporated in the DEI-NT. For markings and display of the limitations see sect.2.5

Outside air temperature gauge: with probe in the fuselage nose, also incorporated in the DEI-NT.

Rear view mirror

Safety bow 10L35/1 in the fin battery box if no battery is installed. (description see section 4.2.5).

Parachute automatic or manual type or a suitable firm back cushion approximately 8 cm (3 in.) thick for the front seat and 3 – 8 cm (1 – 3 in.) thick for the rear seat

Required placards, check lists

Flight manual.

b) Additional equipment for cloud flying

(Not permitted in Canada and Australia, for the US see note in section 2.12)

Variometer

Turn and bank indicator

Note: Experience has shown that the installed airspeed indicator system may be used for cloud flying.

Flight Manual DG-1000M

2.14 Aerotow, winch and autotow launching

2.14.1 Weak links in towing cables

	Winch launching	aerotow
max.	11000 N (2425 lbs.)	11000 N (2425 lbs.)
recommended	10000 N \pm 1000 N (2200 lbs. \pm 220 lbs.)	10000 N \pm 1000 N (2200 lbs. \pm 220 lbs.) for tow behind aeroplanes 6000 N \pm 600 N (1323 lbs. \pm 132 lbs.) for tow behind slow tow planes eg. Ultralight planes or touring motorgliders

2.14.2 Towing cables (for aerotow only)

Length: 40-70 m (130 - 230 ft)

Material: hemp- or plastic fibres

2.14.3 Max. towing speeds

Aerotow	VT =	185km/h (100 kts.)	maximum
Winch- and autotow	VW =	150 km/h (81 kts.)	

2.14.4 Tow Release

The C.G. tow release (installed in front of the main wheel) is suitable only for winch- and auto launching..

The nose hook is to be used only for aerotow.

2.15 Crosswinds

The demonstrated crosswind velocity is 15 km/h (8 kts.) according to the airworthiness requirements.

2.16 Tyre Pressure

Main wheel	3 bar	(43.5 psi)
Tail wheel	4.0 bar	(58 psi)

2.17 Waterballast (Option)

Max. capacity 80 L (21.1 U.S. gal) per wing.

Filling the water ballast is only allowed with a filling system that enables determination of the exact amount of ballast filled, e.g. water gauge or calibrated canisters. Only symmetrical loading is allowed.

After filling, balance the wings by dumping enough water from the heavy wing, see 4.2.3.

Flight with leaking watertanks is prohibited, as this may result in an asymmetrical loading condition.

Warning: Follow the loading chart, see section 6.8.

The max. take-off weight must not be exceeded.

2.18 Trim ballast box in the fin

A box for ballast (trim-weights) is installed in the fin. It can be used to compensate for the mass of the rear pilot and as trim-possibility for heavy pilots.

Warning: Follow the loading chart see 6.8.7.

Tape the cover of the fin ballast box with tape min. 19mm (3/4 in.) wide prior to each flight.

2.19 Other limitations

2.19.1 Approach and landing

Landing with the engine extended and not running is prohibited, except in an emergency.

If longer sinking flights with the engine idling can't be avoided it is recommended to apply some throttle at least every 60 seconds to ensure enough engine lubrication,

If possible always land in the gliding configuration, engine retracted, to be kind to the engine.

Flight Manual DG-1000M

2.20 Limitations placards

DG Flugzeugbau GmbH
 Type: DG – 1000M Serial No.: 10- M
 Year of construction:

	km/h	kts.
Maximum airspeeds		
Winch launching	150	81
Aero-tow	185	100
Manoeuvring V _A	185	100
Rough air	185	100
Maximum speed V _{NE}	270	146
Powerplant extended	185	100
Powerplant extension-retraction	100	54

Approved aerobatic manoeuvres, approved up to a max. mass of 683 kg /1506 lbs:
Pos. Loop, Chandelle, Spin, Stall turn
Maximum mass: 790 kg /1742 lbs.

Other cockpit placards
 see section 7

Gepäck max. 15 kg
baggage max. 33 lbs.

Sollbruchstelle 10000 N
rated load 2200 lbs.

Reifendruck 4 bar
Tyre pressure 58 psi

Tail wheel

Reifendruck 3 bar
Tyre pressure 43.5 psi

Main wheel

Loading chart

Cockpit load	front seat		rear seat		(Parachute included)
	kg	lbs.	kg	lbs.	
maximum	110 kg	242 lbs.	90 kg	198 lbs.	without fin battery
or maximum	105 kg	231 lbs.	105 kg	231 lbs.	
minimum	kg	lbs.	/	/	With fin battery
minimum	kg	lbs.	/	/	

With lower pilot weight necessary ballast must be added.
Warnung: Um die vordere Schwerpunktlage einzuhalten, dürfen schwere Piloten die DG-1000M doppelsitzig nur betreiben, wenn Sie die Masse von vorderem und hinterem Piloten siehe FHB Abschnitt 6.8.7 austrimmen.

Ballast box in the fin
 Min. load in the front seat

<input type="text" value="kg"/>		<input type="text" value="kg"/>
box empty		box filled

At the control-light in the front instrument panel

Warning:
 Rigging of the horizontal tailplane is only permitted with nose down trim-setting!

at the upper left hand side of the fin

LG ext.-retr. up to 185 km/h 100 kts.

Below the controls and control lights for the electrically operated landing gear

Benzin min. 95 Okt. 50:1 **Zweitaktöl 40 I**
petrol min. 95 ROZ. two stroke oil

On top of main bulkhead left hand side and at fuel filler (Option)

- Pre-flight Check**
- Lead ballast (for under weight pilot)?
 - Parachute worn properly?
 - Safety harness buckled?
 - Front seat: pedals adjusted?
Rear seat: seating height adjusted?
 - All controls and knobs in reach?
 - Altimeter?
 - Dive brakes cycled and locked?
 - Positive control check ? (One person at the control surfaces).
 - Trim ballast box in the fin, correct amount filled in? Locking device completely engaged?
 - Battery in the fin? Loading chart regarded?
 - Trim?
- In addition for self launching
- Fuel level?
 - Fuel cock open?
 - Canopy open, propeller circle clear?
 - After engine start close and lock both canopies.
 - Check max. engine RPM, min. 5900RPM.
 - Check both ignition circuits (4000 RPM)
 - Check emergency system (4000 RPM)
 - Runway free?

Altitude in [m]	0-3000	4000	5000	6000	7000	8000
V _{NE} IAS km/h	270	256	243	230	217	205
Altitude in [ft]	0-10000	13000	16000	20000	23000	26000
V _{NE} IAS kts.	146	138	131	124	117	111

Note: Engine limitations are printed on the DEI-NT (see section 7.4).

Flight Manual DG-1000M

3 Emergency procedures

Section	page
3.1 Introduction	3.2
3.2 Canopy jettison.....	3.2
3.3 Bailing out.....	3.2
3.4 Stall recovery.....	3.2
3.5 Spin Recovery	3.3
3.6 Spiral dive recovery	3.3
3.7 Recovery from unintentional cloud flying	3.3
3.8 Flight with asymmetric waterballast	3.3
3.9 Emergency wheel up landing.....	3.4
3.10 Emergency ground loop	3.4
3.11 Emergency landing on water.....	3.4
3.12 Landing with the engine extended and stopped	3.4
3.13 Emergency extension of the electrically operated main landing gear ...	3.5
3.14 Incompletely retracted electrically operated main landing gear	3.5
3.15 Power loss	3.6
3.15.1 Power loss during take-off	3.6
3.15.2 Power loss during flight	3.6
3.16 Fires	3.6
3.16.1 In engine on the ground.....	3.6
3.16.2 In engine in flight	3.7
3.16.3 In the front fuselage in flight (electrical fire).....	3.7
3.16.4 Rear fuselage in flight (engine).....	3.7
3.17 Defective exhaust system.....	3.7
3.18 Loss of electrical power in flight	3.8
3.18.1 With the engine retracted:	3.8
3.18.2 With the engine extended not running:	3.8
3.18.3 With the engine extended and running:	3.8
3.19 Starting the engine with the starter not working:.....	3.8
3.20 Retraction or extension of the power plant with the normal mechanism not working.....	3.8

3.1 Introduction

Section 3 provides amplified procedures for coping with emergencies that may occur. Emergency situations can be minimized by proper pre-flight inspections and maintenance.

Caution: Canopy jettison and bailing out should be practised several times on the ground before flying the aircraft.

3.2 Canopy jettison

To bail out the white-red canopy opening handle (left) has to be operated with your right hand. Open the canopy as far as possible.

If the canopy doesn't stay open (or is not blown away by the oncoming air), but is closed by the air pressure, you have to release the canopy in its closed position by operating the red emergency release handle (right) with your left hand, then push the canopy upwards.

The retaining line of the rear canopy will tear off.

The gas struts will disengage automatically

Warning: If bailing out with the engine running it is necessary to switch off the ignition and retract the engine with the manual switch even with the propeller still turning. The propeller will be stopped by the engine doors. Don't try to stop the propeller vertical and to retract the engine using the normal method.

3.3 Bailing out

First jettison both canopies, then open the safety harness and bail out.

The low walls of the front cockpit allow for a quick push-off exit.

3.4 Stall recovery

Easing the stick forward and picking up a dropping wing with sufficient opposite rudder the glider can be recovered from the stall.

To recognize and prevent the stall, please refer to section 4.5.7.

3.5 Spin Recovery

Apply full opposite rudder against direction of the spin, pause.

Then ease stick forward until the rotation ceases, centralize the controls and carefully pull out of the dive.

The ailerons should be kept neutral during recovery.

Caution: To prevent unintentional spinning do not stall the motorglider. Fly with enough speed reserve especially in gusty conditions and in the landing pattern.

Intentional spins with waterballast are not permitted.

Height loss during recovery aprox. 50-100 m (160-320ft)

max. speed during recovery max. 200 km/h (108 kts.)

3.6 Spiral dive recovery

Apply rudder and aileron in opposite direction and carefully pull out of the dive.

Spiral dive occurs only when spinning more than 2 turns with medium C.G. positions, see section 4.5.16.

To prevent spiral dives intentional spinning should only be executed at aft C.G. positions.

Recovery from unintentional spinning should be done immediately.

3.7 Recovery from unintentional cloud flying

Spins are not to be used to reduce altitude. In an emergency pull out the dive brakes fully before exceeding a speed of 200 km/h and fly with max. 200 km/h (108 kts.) until exiting the cloud.

At higher speeds up to VNE deploy the dive brakes very carefully due to high aerodynamic and g-loads.

3.8 Flight with asymmetric waterballast

If you suspect that the waterballast is not dumping symmetrically, you have to close the dump valves of the wingtanks immediately, to avoid greater asymmetry.

Asymmetry can be verified by the necessary aileron deflection in straight flight at low airspeeds.

When flying with asymmetric waterballast you have to increase the airspeed, especially in turns, so that you can avoid a stall at all costs.

Fly the landing pattern and touch down approx. 10 km/h (6 kts.) faster than usual and after touch down control carefully the bank angle to avoid the wing touching the ground too early.

3.9 Emergency wheel up landing

It is not recommended to execute a wheel up emergency landing, as the energy absorption capability of the fuselage is much smaller than that of the landing gear.

If the landing gear can't be extended touch down with small angle of attack.

3.10 Emergency ground loop

If there is the risk of overshooting the landing strip you have to decide at least 40 m (130 ft) before the end of the field to execute a controlled ground loop:

- If possible turn into the wind!
- At the same time try to lift the tail by pushing the stick forward.

3.11 Emergency landing on water

From the experience with emergency water landing we know that it is likely that the motorglider will dive into the water, cockpit first.

Therefore an emergency landing on water should be the last choice.

In the case of a water landing, however, extend the landing gear.

Recommended procedures :

On downwind leg of the landing pattern: Extend the landing gear, unlock the parachute harness (not the seat harness)

Touch down: With landing gear extended and airspeed as low as possible.

At point of touch-down: Use your left arm to protect your face against possible canopy fracture.

After touch down: Unfasten seat belt harnesses and undo parachute.

Leaving the cockpit under water: If the canopy has not fractured, opening the canopy may be possible only after the forward fuselage is almost completely filled with water.

3.12 Landing with the engine extended and stopped

Due to the drag from the extended engine, the approach should be made not using airbrakes fully extended.

Fully extended airbrakes may result in a heavy and uncomfortable landing. It is recommended to approach somewhat faster than usual.

3.13 Emergency extension of the electrically operated main landing gear

If extending the landing gear via the electrical system is not possible, the landing gear may be extended manually. The extension force is produced by a gas strut.

For emergency extension pull on one of the 2 black-red emergency extension handles (located at the left hand fuselage wall, one in each cockpit), pull the handle until the landing gear is fully extended. The travel is about 15 mm (.6 in.), the extension time about 2 seconds. During extension the centre (red) LED is shining. When the landing gear is fully extended the lower green LED also starts shining. So the green and the red light are shining to display that the landing gear wasn't extended with the normal procedure.

Warning: Don't let the handle go before the green LED starts shining. If you don't pull for long enough, the landing gear will rest in a position not completely extended and will be destroyed at touch down.

Caution: If you execute the emergency extension at high airspeed it may take a longer time until the landing gear is fully extended. You should shorten the time by reducing the airspeed.

Caution: If emergency extension was necessary check the system to detect the failure and repair the system.

Resetting the system for normal operation, see section 4.5.1.3.

3.14 Incompletely retracted electrically operated main landing gear

If the landing gear is not locked the centre (red LED) starts blinking approx. 22 seconds after the start of the retraction.

In this condition the retraction mechanism may be damaged with g-loads exceeding 4 g.

Instruction 1: Extend and retract the landing gear again.

Instruction 2: If instruction 1 was not successful extend the landing gear and land as soon as possible to fix the problem. For the remainder of the flight, don't fly faster than 150 km/h (81 kts.) and avoid abrupt manoeuvres.

3.15 Power loss

Note: The emergency system is designed for engine operation with max. power output as correlated to the throttle setting.

It won't work at conditions with throttle nearly closed and high engine speed e.g. cruise configuration.

In case you are forced to use the emergency system operate the engine at full throttle.

Don't shut the engine down until you have enough altitude to safely reach an airfield.

3.15.1 Power loss during take-off

Switch over to the emergency system. If the engine still refuses to run:

Push the control stick forwards immediately, watch the airspeed indicator!

a) With sufficient runway

- land normally straight ahead with engine extended
- airbrakes as desired

b) With insufficient runway

- decision based on position, terrain and height
- close fuel cock, switch off ignition and main switch

- engine extended increases the sink rate to 1.7 m/s at 95 km/h (340ft/min at 53 kts.)

3.15.2 Power loss during flight

Switch over to the emergency system. If the engine still refuses to run:

Push the control stick forward immediately, watch the airspeed indicator!

Check:

- fuel cock position?
- fuel quantity?

If no change, retract the engine or land with extended engine.

- engine extended increases the sink rate to 1.7 m/s at 95 km/h (340ft/min at 53 kts.)

3.16 Fires

3.16.1 In engine on the ground

- close fuel cock and switch off ignition if the engine is still running
- keep engine extended
- switch off main switch
- use extinguisher, cloth or suitable external means

3.16.2 In engine in flight

- close fuel cock
- switch off main switch
- open throttle fully if engine is still running until engine stops
- if possible retract the engine to quench the fire
- land as soon as possible
- extinguish fire

3.16.3 In the front fuselage in flight (electrical fire)

- switch off main switch
- close ventilation, open swivel air vents and side window
- land as soon as possible if the fire is not extinguished (circuits are effectively protected by circuit breakers)

3.16.4 Rear fuselage in flight (engine)

The red fire warning light will indicate a fire (temperature above 140°C, 284°F in engine compartment)

- close fuel cock
- open throttle fully if engine is still running until the engine stops
- if possible retract the engine to quench the fire
- switch off main switch
- if smoke prevents flying, open ventilation
- land as soon as possible
- extinguish fire

3.17 Defective exhaust system

With a defective exhaust system inside the engine bay partial overheating of the engine bay walls is likely. First the fire resistant paint will swell and protect the structure for a few minutes. With longer operation the structure will be damaged. Therefore the engine has to be shut down as soon as possible, if an exhaust malfunction is suspected.

Malfunction in flight can be detected by a sudden change of engine sound. The engine will produce more noise with higher frequencies. This may happen for example after extension and starting of the engine in the rare case that the exhaust manifold and the muffler don't couple, e.g. if the cable which lifts the muffler is torn.

If such defect occurs in flight, climb only up to safety altitude, stop and retract the engine.

3.18 Loss of electrical power in flight

3.18.1 With the engine retracted:

Continue flying as a sailplane.

3.18.2 With the engine extended not running:

Look for a landing field to do a safe outlanding.

3.18.3 With the engine extended and running:

Don't stop the engine. Fly to the next airfield and land.

The fuel pumps, the coolant pump, the ignition system, both DEI's, the control unit and the ECU will receive electric power directly from the generator to allow engine operation without battery power..

Avoid longer sinking flights with the engine idling as lubrication of the engine will be insufficient.

Therefore stop the engine for the landing or apply some throttle at least every 60 seconds to supply oil to the engine.

Landing with the engine extended see sect. 3.12.

3.19 Starting the engine with the starter not working:

In flight: Extend the engine by switching on the ignition, when engine is extended increase speed as quickly as possible to min. 165 km/h (89 kts.) until the engine starts. Then flare out with max. 2 g. From the beginning of the dive to the lowest point of the procedure you need appr. 150 m (500 ft). Therefore you should not start this procedure below 400 m (1320 ft) above ground.

Otherwise a safe outlanding is preferable.

On the ground: Handstarting the engine is not possible as you can't reach the necessary starting RPM. You may carry out an aerotow and start the engine (see above).

Caution: Operating the starter motor is only possible with a battery voltage higher than 11V prior to the starting attempt, see section 8.8 item 2..

Warning: Jump-starting the engine directly at the starter motor is prohibited, this procedure may destroy the control unit.

3.20 Retraction or extension of the power plant with the normal mechanism not working

Extend or retract the power plant via the manual switch on the instrument panel.

This procedure is only to be followed in an emergency as all safety devices (e.g. against retraction of the engine while running) are by-passed.

Flight Manual DG-1000M

4 Normal procedures

Section	page
4.1 Introduction	4.2
4.2 Rigging and derigging, filling the watertanks, refuelling	4.2
4.2.1 Rigging	4.2
4.2.2 Extension and retraction of the electrically operated main landing gear 4.4	
4.2.3 Filling the wing water ballast tanks	4.5
4.2.4 Ballast box in the fin	4.6
4.2.5 Installation of a battery in the fin	4.7
4.2.6 Refuelling	4.7
4.2.7 Derigging.....	4.7
4.3 Daily Inspection	4.8
4.3.1 A Inspection prior to rigging:.....	4.8
4.3.2 Inspection after rigging - Walk around the aircraft	4.9
4.4 Pre-flight Check	4.13
4.5 Normal procedures and recommended speeds.....	4.14
4.5.1 Electrically operated main landing gear.....	4.14
4.5.2 Engine starting, taxiing procedures.....	4.16
4.5.3 Self-launching, take-off and climb.....	4.18
4.5.4 Assisted launch.....	4.19
4.5.5 Free flight	4.21
4.5.6 Cruise engine on.....	4.22
4.5.7 Engine stop retraction and extension – start in flight	4.23
4.5.8 Approach and landing	4.25
4.5.9 Engine retraction on the ground	4.26
4.5.10 Flight with water ballast (Option).....	4.27
4.5.11 Flight at high altitude and at low temperatures.....	4.28
4.5.12 Flight in rain and thunderstorms	4.29
4.5.13 Cloud flying.....	4.29
4.5.14 Aerobatics.....	4.30
4.6 Flight with the engine removed from the aircraft	4.33

4.1 Introduction

This section provides checklist and amplification procedures for the conduct of normal operation. Normal procedures associated with optional systems can be found in section 9.

4.2 Rigging and derigging, filling the watertanks, refuelling

4.2.1 Rigging

1. Open the rear canopy.
2. Clean and lube the pins, bushings and the control connections.
3. Rigging the inboard wing panels:

All controls hook-up automatically. Therefore set the airbrake handle to the forward stop.

Ailerons should be held neutral for rigging, airbrakes must be locked.

Screw one of the rear wing securing pins on the tool W 38/2.

Close both canopies. Push the right wing panel into place. Insert the rear securing pin with the tool at the rear attachment fitting. Push in the tool so far that the upper surface of the brass part of the tool is flush with the wing surface. Screw off the tool. Check if the locking device for the securing pin has engaged.

Note: If the wing refuses to slip close to the fuselage, you may try to insert the rigging pin W58 instead of the locking pin and try to move the wing towards the fuselage with help of the conical shape of this pin.

Screw the other securing pin onto the tool.

Open the rear canopy. Push in the left wing. Mount and check the left securing pin by the same method as the right side.

Push the two main pins in as far as possible.

Turn the handles up to the fuselage wall, while pulling out the white securing knob, then release the knob back to its locked position.

Flight Manual DG-1000M

4. Rigging of the stabilizer

Battery box in the fin: Check if the securing wire 10L35 (made from piano wire) is installed. If a battery is to be installed refer to section 4.2.5, connect the battery.

Caution: Rigging of the horizontal tailplane is only permitted with nose down trim-setting. Therefore operate the trim release lever and push the control stick forward, then release the lever to engage the trim (don't operate the trim control knob, the trim should not be pushed to the most nose down position).

Screw the tool W 38/2 into the securing plate (near the top of the left surface of the fin). Pull out the securing plate with the tool, move it downwards to engage in the rigging position. Set the stabilizer on, so that the roller at the fuselage side push rod is inserted into the funnel at the elevator.

Monitor the procedure carefully!

When the stabilizer is set down and laying on the fin, push it aft. The roller will engage and slide forward in the funnel if you hold the elevator in the pertinent position.

Release the securing device by pulling out with the tool and engage the securing device by lifting the tool. The securing plate must be flush with the surface of the fin. Screw out the tool.

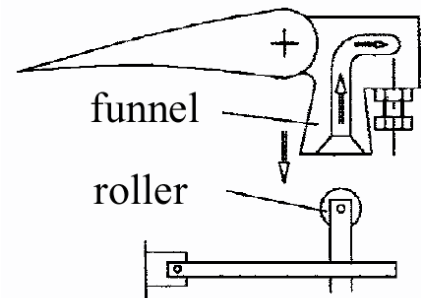

Check for correct elevator connection by looking from the rear into the gap at the right hand side of the rudder.

5. Rigging of the outboard wing panels: Insert the wing tip extensions into the wing. Press in the locking pin with your finger. Insert the wing tip until the aileron connector starts to slide onto the aileron. Strike firmly with the palm of your hand on to the wing tip to lock in the wing tip extension.
6. Tape the gaps of the wing-fuselage junctions and the wing joints.
7. Execute a positive control check, one helper to hold firmly the control surfaces is needed.

4.2.2 Extension and retraction of the electrically operated main landing gear

For extension switch the toggle switch down and let go. The landing gear will be extended and locked, (see section 4.5.1.1).

Warning: The main landing gear can only take up the weight of the glider when fully extended and locked. Therefore it is essential that during extension of the landing gear no load is applied to the main wheel. Lift the trailer ramp high enough. If there is a risk that the ramp may come down while the landing gear is extending secure the ramp, e.g. with blocks.

If such a case happens nevertheless switch the landing gear to retraction. To accomplish this you must switch up and hold the toggle switch and press the press button simultaneously 3 times within 2 seconds.

Warning: If you operate the retraction or extension the landing gear will travel to the up or down stop. So make sure that there are no obstacles which may be caught by the landing gear to prevent damage or injuries.

You can stop the travelling by switching the toggle switch in the reverse direction and pressing the press button simultaneously (only during retraction)

4.2.3 Filling the wing water ballast tanks

Open the right wing tank valve (top handle). Place the right wing tip on the ground. Attach the hose in the water outlet on the lower surface of the wing. Fill with water. Close the valve.

Place the left wing tip to the ground and fill the left tank accordingly. Filling with water ballast is only allowed with a filling system which enables you to determine the exact amount of ballast filled in, e.g. water gauge or calibrated canisters.

Warning: Fill the hose from your water containers but never from a main pressure water supply. Filling the wing tanks with excessive pressure (more than 0.2 bar, 3 psi) will definitely damage the wing shell!

Caution: If the tanks are to be filled up completely you must suck the air out of the tanks with the filling hose, as the tanks have no ventilation line.

Fill with the desired amount of water regarding the loading chart see section 6.8.5.

In case a valve leaks slightly, you may try to pull out the PVC pushrod of the valve to stop the leak. If this cannot be done successfully refer to maintenance manual 1.8.2 and 4.1.

It is not allowed to fly with leaking watertanks, as this may result in asymmetrical loading condition.

After filling the tanks, check to see if the wings are balanced. If one wing is heavier, dump enough water to balance the wings.

Finally press the teflon-glass-fabric which shall close the dump holes against the wing-shell. There must always be a small amount of grease on the shell, to ensure that the covers stick to the shell.

Warning: Follow the loading chart section 6.8 must be observed. The maximum take-off weight must not be exceeded.

4.2.4 Ballast box in the fin

To fill the ballast box remove the Plexiglas cover plate by inserting a 6mm pin into the hole of the upper locking device and move the locking pin downwards. Determine the amount of trim-weights according to section 6.8.7. Slide the weights into the rails of the box. The heavy weights with 2,4 kg (5.3 lbs.) each must be installed in the lower 4 sections and the lighter weights with 1,2 kg (2.65 lbs.) each in the upper 2 sections. It doesn't matter in which sections the weights are installed (in the case that not all sections are filled up), but it is not allowed to insert the light weights into the sections for the heavy weights. Close the compartment.

Warning: Check that the locking device has engaged completely.

Tape the cover of the fin ballast box with tape min. 19mm (3/4 in.) wide prior to each flight.

A control light in the front instrument panel starts blinking after each transaction with the weights. By counting the amount of blinks, the amount of ballast can be determined. for a heavy weight 2 blinks appear and 1 blink for a light weight, this means 10 blinks if the box is filled up completely. After a pause of 2-3 seconds the blinking will be repeated etc. The blinking can be stopped by pressing on the control light. Pressing again on the control light reactivates the blinking feature.

After filling the ballast box you should check the correct indication of the control light.

A switch will be operated by the locking pin of the ballast box cover when the pin locks correctly.

As long as the switch is not closed, the control light for the ballast box will blink with doubled speed without interruption. The blinking can't be switched off by pressing on the control light contrary to the blinking which indicates the amount of ballast.

Caution: When changing trim ballast, check condition and correct gluing of the foam rubber rings 10L45/2 in the ballast box in the fin. Without these rings a correct indication is not possible.

Replace damaged rings according to Service Info 67-07, attached to the MM.

4.2.5 Installation of a battery in the fin

A battery in the fin may be installed **optionally**.

To accomplish the installation the locking bow (part 10L35 made from piano wire) must be removed. The locking bow prevents the installation of a battery and serves as indicator if a battery is installed, as its ends are visible from the outside.

After removing the battery reinstall the locking bow.

Warning: The fin battery raises the min. cockpit load see section 6.8.4.

Only the use of the factory supplied battery Z110 (mass 5.5 kg, 12.1 lbs.) is permitted. Do not put any other objects in the battery box.

4.2.6 Refuelling

Fuel is transferred via a permanently installed refuelling pump from a can where the correct amount of oil is added and mixed prior to filling.

Oil: Use only super two stroke oil according to section 2.6.

Switch on the main switch of the aircraft.

Couple the fuel filler hose to the fuselage side coupling located in the baggage compartment.

Start the pump by pressing the push button mounted in the main bulkhead (rear cockpit left hand side). As soon as the fuselage tank is full a built in device automatically switches off the pump. If you want to interrupt or to stop the filling procedure before the tank is full press again the push button. Starting the pumping again is possible by pressing the push button again.

Optional: Refuelling is also possible via the optional tank filler opening on the fuselage exterior surface. If you can't fill premixed fuel (e.g. at the airfield petrol station), half fill the tank with fuel, then add the proper amount of oil and fill up completely.

Caution: If when pressing the push button the re-fuelling pump doesn't start running and the DEI fuel level indication changes immediately to 41 L, the tank full sensor is defective. In such a case refuel via the tank filler opening (if installed) up to the sensor. Otherwise the fuel level gauge will display a higher fuel level than correct. Exchange the sensor as soon as possible.

If no fuel filler opening is installed you have to replace the sensor to be able to re-fuel.

Warning: Make sure to fill in clean fuel without any water.

4.2.7 Derigging

Derigging follows the reverse of rigging.

Waterballast must be dumped first.

Lock the airbrakes.

For disassembling the securing pins of the wings the tool W 38/2 must be screwed into the thread completely.

The brass part of the tool will then disengage the securing of this bolt.

Flight Manual DG-1000M

It is recommended to leave the securing pin in the right wing while you derig the left wing.

Derigging of the outboard wing panels:

Use a 6 mm diameter pin (e.g. tool W36) for pressing in the locking pin on the wing's upper surface. Pull out the wing tip or the wing tip extension.

4.3 Daily Inspection

Please bear in mind the importance of the inspection after rigging the glider and respectively each day prior to the first take off. It is for your safety.

Caution: After a heavy landing or if other high loads have been imposed on your motorglider, you must execute a complete inspection referring to maintenance manual sect. 2.3 prior to the next take off. If you detect any damage, don't operate your aircraft before the damage is repaired. If the maintenance and repair manuals don't give adequate information, please contact the manufacturer.

4.3.1 A Inspection prior to rigging:

1. Wing roots and spar ends:-
 - a) Check for cracks, delamination etc.;
 - b) Check the bushes and their glued connection in root ribs and the spar ends for wear;
 - c) Check the control hook-ups at the rootrib for wear and corrosion;
 - d) Check the strings which hold the waterbags for sufficient tension (see maintenance manual sect. 4.1)
2. Fuselage at wing connection:-
 - a) Check the lift pins for wear and corrosion;
 - b) Check the control hook-ups including the water dump system for wear and corrosion.
3. Top of the vertical fin:-
 - a) Check the mounting points of the horizontal tailplane and the elevator control hook-up for wear and corrosion
 - b) Check if the securing wire see section 4.2.5 is installed or if a fin battery (Option) is installed and connected
4. Horizontal tailplane:-

Check the mounting points and the elevator control hook-up for wear and corrosion;
5. Rigging points for the outboard wing panels:-

Check the lift pins and bushes for wear and corrosion and check their glued connections. Check the locking device for function and sufficient spring force.

4.3.2 Inspection after rigging - Walk around the aircraft

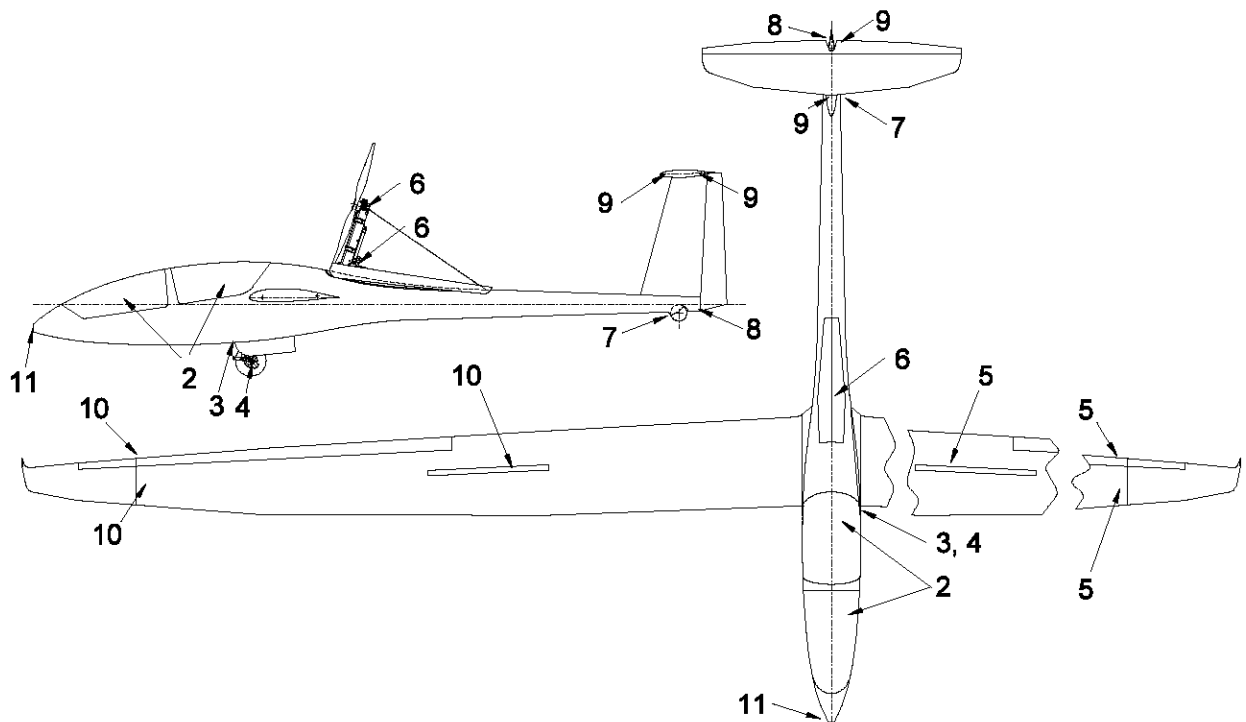

1. All parts of the airframe:-
 - a) Check for flaws such as bubbles, holes, bumps and cracks in the surface;
 - b) Check leading and trailing edges of the wings and control surfaces for cracks;
2. Cockpit area:-
 - a) Check the canopy locking mechanism;
 - b) check the canopy emergency release see section 7.16 (not every day, but min. every 3 month);
 - c) check the main pin securing;
 - d) check all controls for wear and function, incl. positive control check, check if the handle of the pedal adjustment cable will be pulled to the front so that it can't hook into the trim release lever at the control stick, even with pedals in a rear position;
 - e) Check the tow release system for wear and function incl. cable release check;
 - f) Check for foreign objects;
 - g) Check the instrumentation for wear and function;
 - h) Switch on main switch;
 - i) Check the radio and other parts of the electric system (fuses!) for function;
 - j) Check the engine controls, especially the interconnection of front and rear throttle handles;
 - k) Check all fuses, including the battery main fuse which is located behind the foot of the rear instrument panel under the carpet;

Flight Manual DG-1000M

- l) Check the extension-retraction mechanism by operating it in both directions. The extension time should not exceed 10 seconds!
Extend the engine halfway;
 - m) Check the brake fluid level, the reservoir is located left hand side above and behind the main-spar connection;
 - n) Check the fuel level by the DEI-NT.
3. C.G. Tow hook:-
- a) Check the ring muzzle of the C.G. hook for wear and function;
 - b) Check for cleanliness and corrosion;
4. Main landing gear
- a) Check the struts, the gear box, the gear doors and the tyre for wear; dirt in the struts can hinder the landing gear from locking over centre the next time!;
Check the tyre pressure: 3.0 bar – 43.5 psi;
 - b) Check wheel brake and hose for wear and function;
5. Left wing:-
- a) Check locking of the outboard wing;
 - b) Check the aileron for excessive free play;
 - c) Check airbrake- and box and control rod for wear and free play. It must be possible to retract the airbrake, even if it is pressed backwards in direction of flight. If there is any water in the airbrake box this has to be removed;
 - d) Check the locking of the rear wing attachment pin.
6. Powerplant
- Extend the powerplant via the manual switch (ignition off)
- a) Check the connection of spindle drive and gas strut to engine and fuselage. To accomplish this extend the engine only so far, that you still can see the connection to the engine mount. Check especially for cracks in the spindle drive fork.
 - b) Check both bolts of the front engine mount, these bolts are responsible for the correct drive belt tension;
- Note:** The rear bolt takes over the loads of the drive belts, the front bolt acts as securing device in case the rear bolt fails.
- c) Check V-belts for wear and correct tension, sudden loss of tension indicates damage of the bolt see item b);
 - d) Check ignition system incl. wires and the spark plug connectors for tight fit
 - e) Fully extend the powerplant;
 - f) Check the propeller mount for cracks, especially at the welding seams.

Flight Manual DG-1000M

- g) Check all screwed connections and their securing;
 - h) Check the propeller stopper
 - i) Check the rear engine suspension (lower side of engine);
 - j) Check engine retaining cable and its connections in the engine compartment and at the engine;
 - k) Check function of throttle operation;
 - l) Check fuel lines, electrical wires, Bowden cables and structural parts for wear and kinks.
 - m) Check exhaust muffler, propeller mount, radiator, coolant pump and accessories for tight fit and any cracking.
Check especially the rubber mounts of the radiator.
 - n) Check especially the cable which lifts the muffler during engine extension.
 - o) To check the water pump and the fuel pump of the normal system, switch on the ignition. You should hear a buzz. After some seconds as soon as fuel pressure is built up, the fuel pump should stop running;
 - p) Apply strong pressure to the propeller mount in forward, backward and sideways directions to check the rubber engine mounts;
Check the rubber buffer which limits the tilt of the engine against the drive mount due to the engine torque.
 - q) Visual check of the propeller
 - r) Turn the propeller 1 revolution by hand and listen for abnormal sounds which may indicate engine damage
 - s) Drain condensed water from the fuel tank. The drainer is located in the main wheel box on the rear wall on the right hand side.
 - t) Check the outlet of the fuel tank ventline for cleanliness, the outlet is located behind the landing gear box;
 - u) Check the coolant level in the radiator by removing the radiator screw cap. Press down on cap for easier handling. The radiator must be filled up to approx. 25mm (1 in.) below its top.
 - v) Check the coolant hoses visually for leaks and any defects of the outer surface.
7. Tail wheel:-
Check for wear, free play and excessive dirt in the wheel box. Remove excessive dirt prior to take off;
Check tyre pressure: 4 bar -58 psi;
8. Rear end of the fuselage:-
Check the lower rudder hinge and the connection of the rudder cables for wear, free play and correct securing;
Check the bulkhead and fin trailing edge shear web for cracks and delamination;

Flight Manual DG-1000M

9. Fin - horizontal tail:-

- a) Check the upper rudder hinge for wear and free play;
- b) Check the elevator for free play and correct control hook-up , look from the rear into the gap at the right hand side of the rudder;
- c) Check the securing of the stabilizer;
- d) Check the horizontal tail for free play;
- e) Check the TE or Multiprobe for correct insertion and fix it with tape
- f) Check the trim-weight box, correct number of weights, locking device completely engaged, cover plate secured with tape?
- g) Check if a fin battery is installed: If the ends of the locking bow are visible on both sides in the fairings at the upper end of the fin this is the indication that no battery is installed.

Caution: When changing the trim ballast check condition and correct gluing of the foam rubber rings to the mounting plate of the optical sensors in the trim-weight box. Without rings an indication error of the control lamp in the front instrument panel might occur. Replace missing rings according to Service Info 67-07(attached to the maintenance manual).

10.Right wing see item 5.

11.Fuselage nose

- a) Check the ports for the static pressure and the pitot pressure and for the PC pressure (at the lower fuselage side) for cleanliness.
- b) If the motorglider was parked in rain, you have to empty the static ports by sucking out the water at the ports.
- c) Check the nose hook for cleanliness and corrosion.

4.4 Pre-flight Check

1. Lead ballast (for under weight pilot)?
2. Parachute worn properly?
3. Safety harness buckled?
4. Front seat: pedals adjusted?
Rear seat: seating height adjusted?
5. All controls and knobs in reach?
6. Altimeter?
7. Dive brakes cycled and locked?
8. Positive control check ? (One person at the control surfaces).
9. Trim ballast box in the fin, correct amount filled in? Locking device completely engaged?
10. Battery in the fin? Loading chart regarded?
11. Trim?

In addition for self launching

12. Fuel level?
13. Fuel cock open?
14. Canopy open, propeller circle clear?
15. After engine start close and lock both canopies.
16. Check max. engine RPM, min. 5900RPM.
17. Check both ignition circuits (4000 RPM)
18. Check emergency system (4000 RPM)
19. Runway free?

4.5 Normal procedures and recommended speeds

4.5.1 Electrically operated main landing gear

4.5.1.1 Extension and retraction in flight

Retraction: For retraction switch and hold the toggle switch up and press the press button twice within 2 seconds. With each press on the button a signal will sound (only installed up to Ser. No. M4). The landing gear will retract automatically. You may let go of the switches. During retraction the centre (red) LED will shine and the upper green LED will blink. As soon as the landing gear is retracted and locked only the upper green LED will shine.

Warning: If the upper green LED doesn't start to shine and the red LED instead starts blinking refer to section 3.20 emergency procedures.

Extension: For extension switch the toggle switch down and let go. The landing gear will be extended and locked.

During extension the centre (red) LED will shine and the lower green LED will blink. As soon as the landing gear is extended and locked only the lower green LED will shine.

Note: In case of high acceleration during extension or retraction an over current cut off system will switch off the spindle drive to protect the system. As soon as the g-loads decrease, the landing gear will continue to travel.

Note: To save electrical power during flight the upper green LED will stop shining after approx. 5 minutes, landing gear retracted and locked.

4.5.1.2 Extending the landing gear via the emergency extension system

The emergency extension system is also designed to be operated for in flight training purposes. Operation see section 3.13.

Resetting the system for normal operation should be executed after landing, for procedure see section 4.5.1.3.

Caution: It is strongly recommended to train the emergency extension in flight.

Note: Resetting the system for normal operation is also possible in flight.

However, this is only permissible if there are 2 pilots on board, one pilot flying the glider and the other resetting the system.

Then you may retract the landing gear again according to section 4.5.1.1. to continue the flight.

4.5.1.3 Resetting the emergency extension system for normal operation

After an emergency extension the system must be reset for normal operation. To accomplish this you must pull one of the 2 emergency extension handles and simultaneously switch the toggle switch down. The centre (red) and the lower green LED will shine.

Switch and handle must be operated until the centre LED stops shining and only the lower green LED continues shining. The spindle drive will then stop operating, then let go handle and switch.

Note: It may occur that the spindle drive stops before the gas strut is completely reset. Allow the system 5 minutes to cool down and start the resetting process again.

Thereafter you may retract the landing gear again according to section 4.5.1.1.

4.5.1.4 Part extension and retraction for inspection and servicing

The retraction may be stopped by switching the toggle switch down, The extension may be stopped by switching the toggle switch up and pressing simultaneously the press button.

Only the red LED will shine.

For any service work switch off the main switch!

With the procedures described in section 4.5.12.1 you may retract or extend the landing gear again.

4.5.1.5 Precautionary measures against retracting the landing gear while on the ground

If the glider is resting on the main landing gear the landing gear should not be retracted, as retraction will result in damage of the landing gear. To minimise the risk of such operating error the following safety features have been incorporated:

1. If the toggle switch is switched up, nothing will happen.
2. If the toggle switch is switched up and the press button is pressed 1 time a warning tone will sound (only installed in Ser. No. M1 up to M4), otherwise, nothing will happen.
3. The landing gear will be retracted only if one of the following procedures will be used:
 - a) Hold the toggle switch switched up and press the press button 2 times within 2 seconds.
 - b) Hold the press button pressed and switch up the toggle switch 2 times within 2 seconds.

Caution: If you leave the DG-1000M unattended switch off the main switch to prevent any operating error.

4.5.2 Engine starting, taxiing procedures

4.5.2.1 Engine starting on the ground

- a. Check if the fuel cock is open.
- b. Master switch on.
- c. Extend the powerplant:

There are two methods:

1. Extension via the manual switch which is located on the instrument panel. Hold the manual switch up until the extension procedure stops. The powerplant will be raised to its operating position. If you release the switch during the procedure the switch jumps back to the centre position and the extension stops.
2. Switch on the ignition switch in the DEI-NT (the toggle has to be pulled out for switching). The engine will be raised to its operating position automatically. Switch off the ignition, press the manual switch up to switch off the automatic system, otherwise the engine will immediately be retracted automatically.

Warning: When extending the engine via the ignition switch the starter motor may start cranking the engine in case the starter switch got stuck. Caution at the propeller.

- d) Prior to the first engine start of the day turn the propeller min. 1 rotation by hand.
- e) Extend the airbrakes and engage the parking brake.
- f) Switch on the ignition in the DEI-NT, the engine will be extended automatically to its operating position, unless it's already in this position.
- g) Throttle in idle position.
- h) Check that the propeller circle is clear.
- i) Push the starter button until the engine runs.

Thanks to the electronic fuel injection the correct amount of fuel will be delivered to the engine. No further action by the pilot is necessary.

Caution: Operating the starter motor is only possible with a battery voltage higher than 11V prior to the starting attempt, see section 8.8 item 2..

- j) As soon as the engine fires move the throttle slowly forward until the engine runs smoothly.
- k) Adjust the engine RPM to approx. 4000 and check the ignition circuits (magnetos), but not before the engine runs smoothly. A max. drop of 300 RPM is permissible. Do not check longer than for 5 seconds per circuit, otherwise a failure message will appear.
- l) With engine RPM approx. 4000 switch over to the emergency system.. A short RPM drop will occur, thereafter the engine should run with approx. the same RPM as with the normal system.
- m) Switch over to the normal system again.

Flight Manual DG-1000M

n) Check full engine RPM (wheel brake locked on, a helper should lift the fuselage nose), min. 5900 RPM.

Alternatively check the RPM during the initial take-off run.

Warning: If after engine start the message “Starter Run” is displayed on the DEI-NT the starter motor didn’t disengage and produces electric power, stop the engine immediately to prevent damage of the control unit.

4.5.2.2 Taxiing

Taxiing without assistance can be done with the steerable tail wheel and one wingtip on the ground.

Avoid longer taxiing if possible to be kind to the airframe and to the powerplant.

Operate the airbrake handle (connected to wheel brake) with the left hand and the throttle with the right hand.

Set trim fully nose up and pull the control stick to its stop to get pressure on the tail wheel.

Caution: For taxiing always use engine speed such that the engine runs smoothly. This prevents vibration damage at the propeller mount. On concrete it may be necessary to apply a little wheel brake to reduce taxi speed.

4.5.3 Self-launching, take-off and climb

4.5.3.1 Take-off distance

Prior to take-off check according to sect. 5.2.3 if the available runway length is sufficient.

It must be noted that a rising runway, wet or uneven surface, long grass, crosswind etc. will increase the take-off distance considerably.

Self-launching should only be executed if there are possibilities to clear obstacles or for a safe out-landing in case of power loss or engine failure.

If there is any doubt choose a safe tow launch.

4.5.3.2 Start roll and take off

Set trim between neutral and fully nose up.

The take-off roll may be executed with one wing on the ground.

With a crosswind if there is no wing runner the lee-wind wing should be on the ground. The drag of the wingtip wheel partly compensates the moment of the wind on the vertical tail. This technique reduces the tendency to turn the glider into the wind.

Gently apply full throttle, as soon as the aircraft rolls lift the wing by applying aileron.

Hold stick back during start roll until you have enough elevator authority to prevent the DG-1000M from going on the nose.

Then roll on the main wheel until you reach take-off speed.

4.5.3.3 Climb

After take-off accelerate the DG-1000M to $V_y = 95 \text{ km/h}$ (51 kts) and climb with this speed.

Retract the landing gear after reaching safety altitude.

Execute the whole climb with full throttle to ensure a smooth engine run.

Caution: With any engine failure resulting in a sudden RPM loss, immediately switch over to the emergency system, see section 3.15.1.

4.5.4 Assisted launch

Due to the towhook position being in the middle of the fuselage and the excellent effectiveness of the ailerons and rudder, the possibility of wing dropping or ground loops, even on a slowly accelerating aerotow is reduced. Take-off with strong crosswind is possible.

4.5.4.1 Aerotow

Aerotow is permitted only using the nose tow release. Set trim to neutral for aerotow.

Keep the elevator in neutral position.

Don't try to lift off before you reach an airspeed of 80 km/h (43 kts.) (without ballast). On a rough airfield hold the control stick tight. The undercarriage can be retracted at safety height during the tow.

Normal towing speed is 120-130 km/h (65 - 70 kts.).

For a cross country tow the speed can be as high as 185 km/h (98 kts.).

Warning: Aerotow with high take-off weight requires a powerful tow plane. Many tow planes are not certified to tow gliders with high take-off weights. Reduce the take-off weight if necessary!

Flight Manual DG-1000M

Note: Aerotowing behind slow tow planes eg. Ultralight planes or touring motorgliders:

The take-off distance may be remarkably reduced if the DG-1000M is towed with the engine extended and running at full power.

Recommended towing speed is 100km/h (54 kts.).

To ensure good communication with the tow pilot the use of a headset is required at least for the pilot in command.

Warnings:

1. Due to the shorter take-off distance the aerotow with engine extended and running is safer than with engine retracted. Nevertheless this take-off procedure is only permitted if the conditions are such that a tow with engine retracted will also be safe.
2. If the engine of the DG-1000M fails the tow must be terminated by releasing the towing cable, this procedure is applicable as long as the aircraft are still on the ground.
3. The DG-1000M pilot should keep his left hand at the throttle handle to enable him to close the throttle immediately in case the tow-plane terminates the tow (This is a standard procedure for powered aircraft pilots).
4. In case of termination of the tow when the DG-1000M is still on the ground close the throttle immediately, then release the towing cable and apply the wheel brake.
5. In case of termination of the tow when the DG-1000M is already in the air take the hand from the throttle, release the towing cable and continue the climb with full throttle. This is still applicable in case the tow plane remains on the ground.
6. If the tow is so fast that the DG-1000M engine may overspeed reduce the throttle as necessary. For a fast cross country tow the powerplant must be retracted.

4.5.4.2 Winch launch

Winch launch is only allowed using the C.G. tow hook!

Set the trim to neutral for winch launch.

Caution: During ground roll and initial take-off (especially when flying solo) push the control stick to a forward position to prevent excessive nose-up pitching rotation during initial take-off.

After reaching safety altitude gradually pull back on the stick, so that the glider will not pick up excessive speed. Don't pull too hard.

After reaching release altitude pull the tow release knob.

Recommended winch launch airspeed 110-130 km/h (60-70 kts.).

Caution: Do not fly at less than 110 km/h (60kts.) or not more than 150 km/h (81 kts.).

Warning: Winch launch with high take-off weight requires a powerful winch!

4.5.5 Free flight

Stalling characteristics (level and turning flight)

When stalled the DG-1000M will warn by buffeting. If the stick is pulled further the DG-1000M will drop one wing.

Only at forward C.G. positions can the DG-1000M be flown in stall without wing dropping. Maintain control during stalled flight only with the rudder, holding the ailerons neutral.

With stick forward and opposite rudder if required, the DG-1000M can be recovered without much loss of height. Rain does not influence this behaviour noticeably. The loss of height is approx. 50 m (160 ft).

Stall airspeeds see section 5.2.2.

Caution: Flights in conditions conducive to lightning strikes must be avoided.

4.5.6 Cruise engine on

The engine of the DG-1000M is not designed for continuous cruise engine on. Due to the drag of the extended powerplant and as the propeller is designed for optimum climb performance, cruise with higher speed is not efficient.

The optimum cruise is with the so called sawtooth technique. After climb with V_y retract the engine and glide with airspeed according to the McCready theory, flying slowly in lift and faster in sinking air.

The medium cruise speed achieved by sawtooth technique is not much less than for level engine on cruise, but the range will be 2.2 times longer.

Performance data see sect. 5.3.3.4.

However if you decide to perform a cruising flight we recommend an engine speed of 6300 RPM. You will achieve a cruising speed of 150 km/h (81 ks.)

Note: The emergency system is designed for engine operation with max. power output as correlated to the throttle setting.

It won't work at conditions with throttle nearly closed and high engine speed e.g. cruise configuration, see section 3.15.

In case you are forced to use the emergency system, try to change to climb configuration and operate the engine at full throttle.

Don't shut the engine down until you have enough altitude to safely reach an airfield.

4.5.7 Engine stop retraction and extension – start in flight

4.5.7.1 Stopping and retracting the engine in flight

1. Fly at 85-95 km/h (46-51 kts).
2. Bring the throttle back to idle.
3. Switch off the ignition.
4. The engine will be slowed down by itself if you fly with the airspeed see 1.
5. As soon as the propeller stopped turning, the powerplant will be automatically retracted a little (intermediate position). When the powerplant is retracted into the intermediate position the propeller stopper moves forward in the propeller circle. As soon as the propeller is in the position for retraction (close to the stopper) the engine will retract by itself.

To save altitude you may turn the propeller into the position for retraction (ignition switched off) by pressing the starter button.

The starter motor receives only pulses of electric power to turn the propeller slowly.

Approx. 10° before the propeller reaches the retraction position, let go of the starter button so that the airstream will move the propeller towards the stopper (if the propeller hits the stopper too fast the propeller may push the stopper aside and the propeller must be rotated again into the retraction position).

Note: If turning the propeller with the starter motor doesn't work, you may turn the propeller by increasing the airspeed. Watch the procedure in the mirror!

6. The engine will retract by itself.

Note: In case the automatic retraction is defective, the engine must be retracted via the manual extension-retraction switch.

Caution: With high temperatures (temperature on ground above 25°C/77°F) there is the risk of overheating the propeller after engine retraction. To avoid damage, extend the engine again via the manual switch (approx. 1 second) to open the engine doors, retract again after 5 minutes.

4.5.7.2 Extension and starting the engine in flight

1. With the engine extended but not running the rate of sink at 90 km/h (49 kts) increases to 1.7 m/sec. (340 ft/min.).

Therefore restarting the engine should only be done over landable terrain and not below 400 m (1320 ft) above ground. But it is better to restart the engine at 200 m (660 ft) over a landable field rather than at 400 m (1320 ft) over a forest or unlandable scrub.

Should a flight be conducted over a wide expanse of unlandable terrain, the engine should then be restarted at 1000 m (3300 ft) above ground level so that if the engine does not start, all the emergency starting procedures can be followed unhurriedly including retraction of the engine if necessary.

2. In a normal restarting situation the loss of altitude from starting the extension procedure until the engine is running is only about 20 m (70 ft).
3. Extension: Fly at 85-95 km/h (46-51 kts).

Check if the fuel cock is open.

Throttle on idle, switch on the ignition. The engine will extend by itself. You may press the starter button before the engine is extended completely. The starter motor will start the engine as soon as the powerplant is extended.

When the engine fires, release the starter button and move the throttle slowly to full throttle.

Warning: If after starting the engine the failure message "Starter Run" will be displayed, the starter motor didn't disengage and is producing electric power, stop the engine immediately to prevent damage of the control unit.

4.5.8 Approach and landing

4.5.8.1 Normal landing

It is recommended to dump the waterballast before landing even on airfields. Dump the ballast before an outlanding in any case.

Abeam the landing point extend the landing gear. In calm weather approach with approx. 105 km/h (57 kts.) (ballast dumped!). With strong wind and / or waterballast fly faster! The very effective Schempp-Hirth dive brakes make a short landing possible.

Slipping may be used as additional landing aid.

Caution: While side-slipping the rudder is held in its deflected position by the airflow. So it is recommended to practice slipping at a higher altitude.

The slip can be introduced at the recommended approach speed see above. To recover from the slip neutralize the aileron control first, this will reduce the force which sucks the rudder in its displaced position.

During the slip the airspeed indicator shows airspeed values which are too low, so the slip must be executed with regard to the position of the horizon. No influence on the slipping characteristics when slipping with partially filled waterballast is noticeable.

Strong crosswind presents no problem.

Do not approach too slowly with fully extended airbrakes otherwise the aircraft may drop during flare out. When flaring out keep the airbrake setting you were using, opening them further may drop the motorglider!

You can land the DG-1000M on soft fields with the landing gear extended, as there is no tendency of nosing over. During touch down pull the stick completely to avoid the fuselage nose touching the ground.

After landing in a muddy field clean the landing gear and tow releases.

4.5.8.2 Landing with the engine extended and stopped

See emergency procedures sect. 3.12.

Land with the engine extended and stopped only if the engine can't be retracted.

4.5.8.3 Landing with the landing gear retracted

Wheel-up landing is not recommended see emergency procedures section 3.9.

After wheel-up landing check the fuselage belly and the tow hook for damage.

4.5.8.4 Landing with asymmetric waterballast

See emergency procedures section 3.8

4.5.9 Engine retraction on the ground

Caution: After ground test runs don't retract the powerplant immediately.

Allow the engine to cool down several minutes.

For retraction turn the propeller by hand into position, don't use the starter motor.

The engine will be retracted automatically. To interrupt the retraction procedure proceed as follows:

Push the manual switch up or down to switch off the automatic system.

Further retraction via the manual switch or by switching the ignition on and off.

4.5.10 Flight with water ballast (Option)

4.5.10.1 General

The capacity of the waterballast is selected to allow a high wing loading also in case the powerplant is removed.

With powerplant installed and full cockpit load only a small amount of waterballast may be filed in.

Caution: Do not exceed the maximum gross weight when loading the water ballast. The maximum quantity of water allowed is dependent on the empty weight and the cockpit load (see section 6).

In flight the water drains at approx. 0.5 lt./sec. (1.1 lbs./sec).

4.5.10.2 Filling the waterballast

See section 4.2.3. After filling level the wings and check if the dump valves are tight. It is not allowed to fly with leaking watertanks as this may result in an asymmetric loading condition.

4.5.10.3 Dumping of the waterballast

Open both wing ballast tanks together. Do not empty one wing tank after the other to avoid an asymmetric loading condition.

4.5.10.4 Valves leaking, servicing

Please refer to the maintenance manual sect. 1.8 and 4.1.

4.5.11 Flight at high altitude and at low temperatures

With temperatures below 0°C (32°F) for instance when wave flying or flying in winter, it is possible that the control circuits could become stiffer. Special care should be taken to ensure that there is no moisture on any section of the control circuits to minimize the possibility of freeze up. It could be advantageous to apply Vaseline along all the edges of the airbrake cover plates to minimize the possibility of freezing closed.

Operate the controls regularly to prevent ice build-up.
It is not allowed to carry waterballast.

Caution: At temperatures below -20°C (-4°F) there is the risk of cracking the gelcoat.

Caution: The antifreeze in the coolant is mixed normally for a lowest OAT of -20°C. For altitude flights where lower temperatures may be expected you have to change the mixture for lower temperatures, see MM section 4.10.5.1..

Caution: Attention must be paid to the fact that at higher altitudes the true airspeed is greater than the indicated airspeed.

The max. speed V_{NE} is reduced. See the following table:

Altitude in [m]	0-3000	4000	5000	6000	7000	8000
V_{NE} indicated km/h	270	256	243	230	217	205

Altitude in [ft]	0-10000	13000	16000	20000	23000	26000
V_{NE} indicated kts.	146	138	131	124	117	111

Caution: Dump the water ballast before you reach freezing altitude or descend to lower altitudes.

Caution: Do not fly below 0°C (32°F) when your glider is wet (e.g. after rain).

4.5.12 Flight in rain and thunderstorms

With light rain the stall speed and the sink rate increases slightly and the approach speed has to be increased.

Warning: Flights and especially winch launches in the vicinity of thunder storms should be avoided. Due to lightning discharge, carbon fibre structures may be destroyed.

4.5.13 Cloud flying

Cloud flying is approved but only up to a max. mass of 683 kg /1506 lbs (single seated or with 2 light pilots). Take care to fly smoothly and coordinated. It is prohibited to use a spin as a method for reducing altitude in cloud. In case of emergency, pull out the dive brakes fully before exceeding a speed of 200 km/h and dive with max. 200 km/h (108 kts.) to leave the cloud.

Warning: Flying in or near thunderstorm-clouds is prohibited.

Note: Cloud flying is not permitted in Canada and Australia.

Note for the US: "Cloud Flying" is considered flying in Instrument Meteorological Conditions (IMC) and requires an Instrument Flight Rules (IFR) clearance in the U.S. This is permissible in the U.S. provided the pilot has the appropriate rating per 14 CFR 61.3, the glider contains the necessary equipment specified under 14 CFR 91.205, and the pilot complies with IFR requirements.

Flight Manual DG-1000M

4.5.14 Aerobatics

Warning: Aerobatics are approved but only up to a max. mass of 683 kg /1506 lbs (single seated or with 2 light pilots).

Caution: The DG-1000M is a high performance motorglider. Therefore the speed increase in the dive is high.

Training aerobatics therefore should only be executed after a rating with an experienced pilot, or if you can master the manoeuvres on other motorglider types.

In any case don't try to execute the manoeuvres with entry speeds other than those listed.

Caution: Do not make full or abrupt control movement above the manoeuvring speed $V_A=185$ km/h (97 kts.). At speeds between V_A and $V_{NE}=270$ km/h (146 kts.) reduce the control movements accordingly. At V_{NE} only 1/3 of the max. control movements are allowed, see section 2.2.

Warning: Execute only the approved manoeuvres.

Aerobatics only approved without waterballast, powerplant retracted or removed and with the weight of the rear pilot compensated by ballast in the ballast box in the fin see section 6.8.7.

Approved manoeuvres	Entry speed	g-loads
Spin	/	/
Inside loop	180 - 200 km/h (97 - 108 kts)	4.0
Chandelle	180 - 200 km/h (97 - 108 kts)	3.5
Lazy Eight	180 - 200 km/h (97 - 108 kts)	3.5
Stall turn	200 - 220 km/h (108 - 119kts)	4.0

Spins

Caution: Prolonged spinning is satisfactorily accomplished **with aft C.G. positions**. If prolonged spinning is intended, ballast in the ballast box in the fin should be used to achieve an aft C.G. position, see section 6.8.7.

It is not necessary to extend the dive brakes during spin recovery. The DG-1000M displays a large nose down pitch attitude after leaving the spin. So you have to flare out correspondingly.

With **medium and forward C.G. positions** prolonged spinning is not possible. The DG-1000M will terminate the spin by itself after a certain number of turns dependent on the C.G. position. The nose down pitch and speed will be high so with these C.G. positions not more than 1 turn spins should be executed, to avoid high g-loads.

In addition there is a tendency that the spin will turn into a spiral dive after 1 or 2 turns. On reaching this state you must recover immediately.

Inducing the spin: Gradually bring the motorglider into a stall. When buffeting starts, pull the stick back completely and kick in full rudder in the direction of spin.

Recovering from the spin: Apply full rudder opposite to the direction of spin, then ease stick forward until the rotation ceases. Centralize the controls and carefully pull out of the dive. The ailerons should be kept neutral during recovery. Height loss during recovery is approx. 100 m (320 ft), the max. speed is 200 km/h (108 kts.).

Flight Manual DG-1000M

Stall turn

To fly a stall turn safely, proceed as follows:

Don't choose an entry speed of less than 200 km/h (108 kts.).

During the pull out, when reaching the vertical flight path initiate rotation at min. 150 km/h (81 kts.) with the rudder. Push the rudder quickly, but not abruptly. During the turn apply a little aileron against the direction of turn and full forward stick deflection to execute the turn correctly in one plane.

As soon as you reach the vertical dive, start to pull out of the dive to minimize the increase of airspeed and the g-loads.

Be careful not to exceed the airspeed for max. control surface deflection as indicated in section 2.2.

Caution: A classical stall turn with almost no airspeed at the highest point of the turn is very difficult to fly with a glider with larger wingspan, due to the high moment of inertia. This effect is taken into account when using the above mentioned procedure.

Only a pilot who is trained in the technique to execute during the pull up a slight side-slip (with a little aileron deflection in the intended turn direction and appropriate rudder deflection against turn direction) can start to initiate the rotation at a lower speed of 120 km/h (65 kts.) with fast rudder deflection. The turn will look nicer and be narrower than with the method described above.

Warning: If the rudder is applied too late and the rotation is insufficient, it is possible that the glider tailslides (falls tailwards) or falls sideways. If this happens it is important to hold all controls firmly, preferably at one of the stops, until the nose swings down. Then, immediately perform a flare out. Otherwise, due to the reverse airflow, the control surfaces may flap against their stops and be damaged. In addition holding the control stick at the stop prevents the stick from making unnecessary movements due to the mass balance weights in the elevator control system.

Flight Manual DG-1000M

4.6 Flight with the engine removed from the aircraft

The DG-1000M can be flown without the engine when the engine is sent for a major overhaul, or removed to decrease the aircraft empty weight for competition flying or for aerobatics.

The following items must be executed: (see sect. 4.10.9 in the maintenance manual).

1. Remove the powerplant. Spindle drive, gas struts and exhaust system remain in the fuselage.
Insulate the terminal of the starter motor positive wire (in the engine compartment).
2. In addition to the on-board battery install a battery in the fin see section 7.17.6.
3. Carry out a C.G. calculation according to section 6.9. The in-flight C.G. will be moved forward by approx. 75 mm (3 in.) depending on the flight mass and empty mass C.G.
This C.G. shift is acceptable, as the forward limit of the in-flight C.G. for operation with engine removed is 120 mm in front of the C.G. with engine installed.

Item	mass		C.G. behind datum		moment	
	kg	lbs.	m	ft.	kg×m	ft.×lbs.
Mass reduction						
engine with propeller	-58	-127.9	1.261	4.14	-73.14	-529.0
Additional mass						
fin battery	5.5	12.1	5.34	17.52	29.37	212.4
Difference	-52.5	-115.7	0.834	2.735	-43.77	-316.6

4. Fix the limit switch “engine retracted” with a Ty-rap in the actuated position. Otherwise the DEI-NT will remain in the powered flight mode.
5. Tape the engine doors carefully with fabric tape.

Note: After switching on the main switch some failure messages will be displayed. Confirm each message by pressing the selector switch to eliminate the message.

Flight Manual DG-1000M

5 Performance

Section	page
5.1 Introduction	5.2
5.2 Approved data	5.3
5.2.1 Airspeed indicator system calibration.....	5.3
5.2.2 Stall speeds.....	5.5
5.2.3 Take-off performance.....	5.6
5.3 Additional Information.....	5.8
5.3.1 Demonstrated crosswind performance.....	5.8
5.3.2 Gliding performance	5.8
5.3.3 Performance under power	5.10
5.3.4 Noise data.....	5.12

Flight Manual DG-1000M

5.1 Introduction

This section provides approved data for airspeed calibration, stall speeds and take-off performance and non-approved additional information.

The data in the charts has been computed from actual flight tests with the motorglider in good and clean condition and using average piloting techniques.

5.2 Approved data

5.2.1 Airspeed indicator system calibration

- IAS = indicated airspeed
- CAS = calibrated airspeed
- 1 kts = 1 km/h / 1.852

Caution: The airspeed indicator is to be connected to the static ports and pitot probe in the fuselage nose.

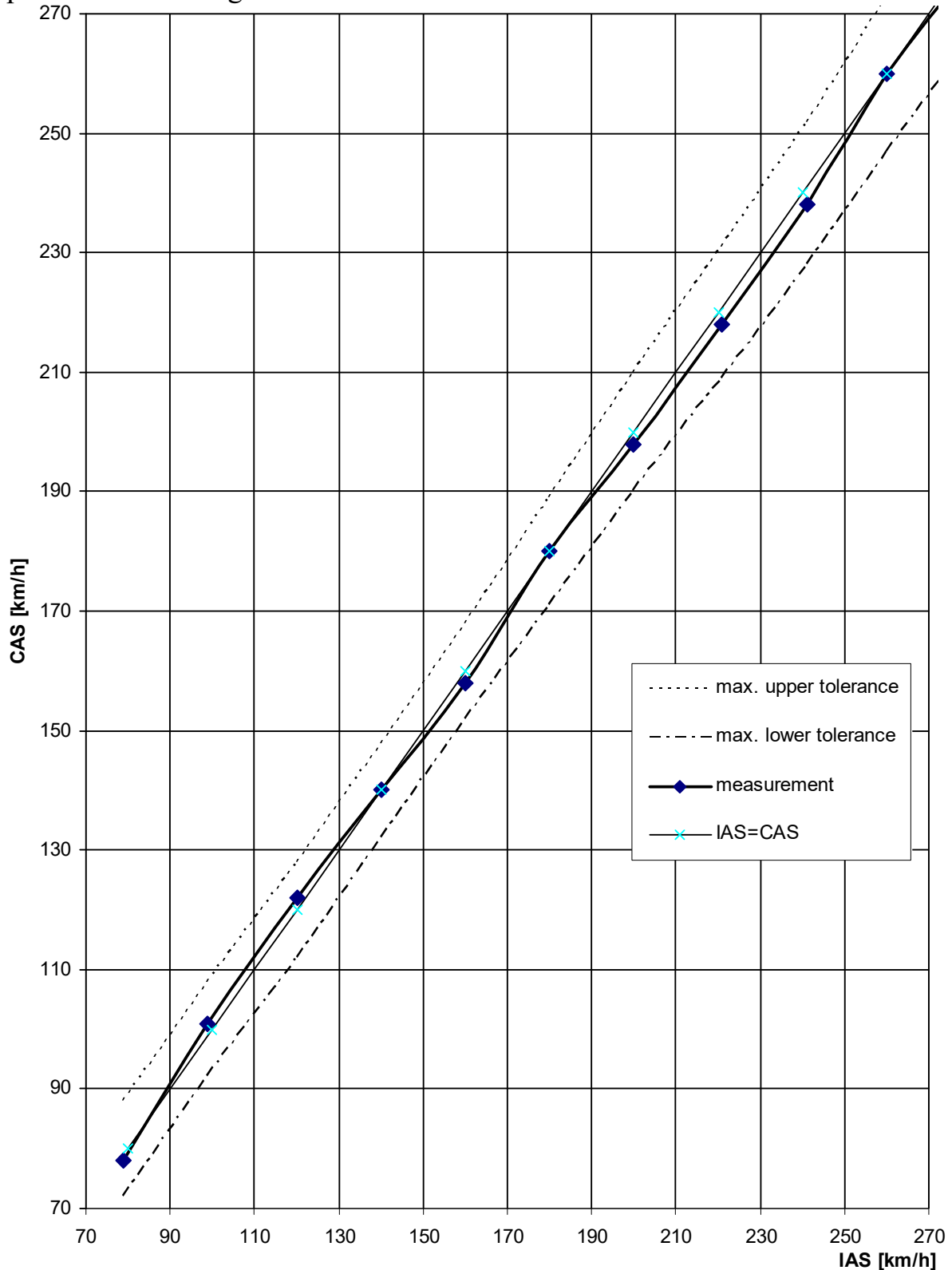

Flight Manual DG-1000M

Airspeed indicator system calibration British, US

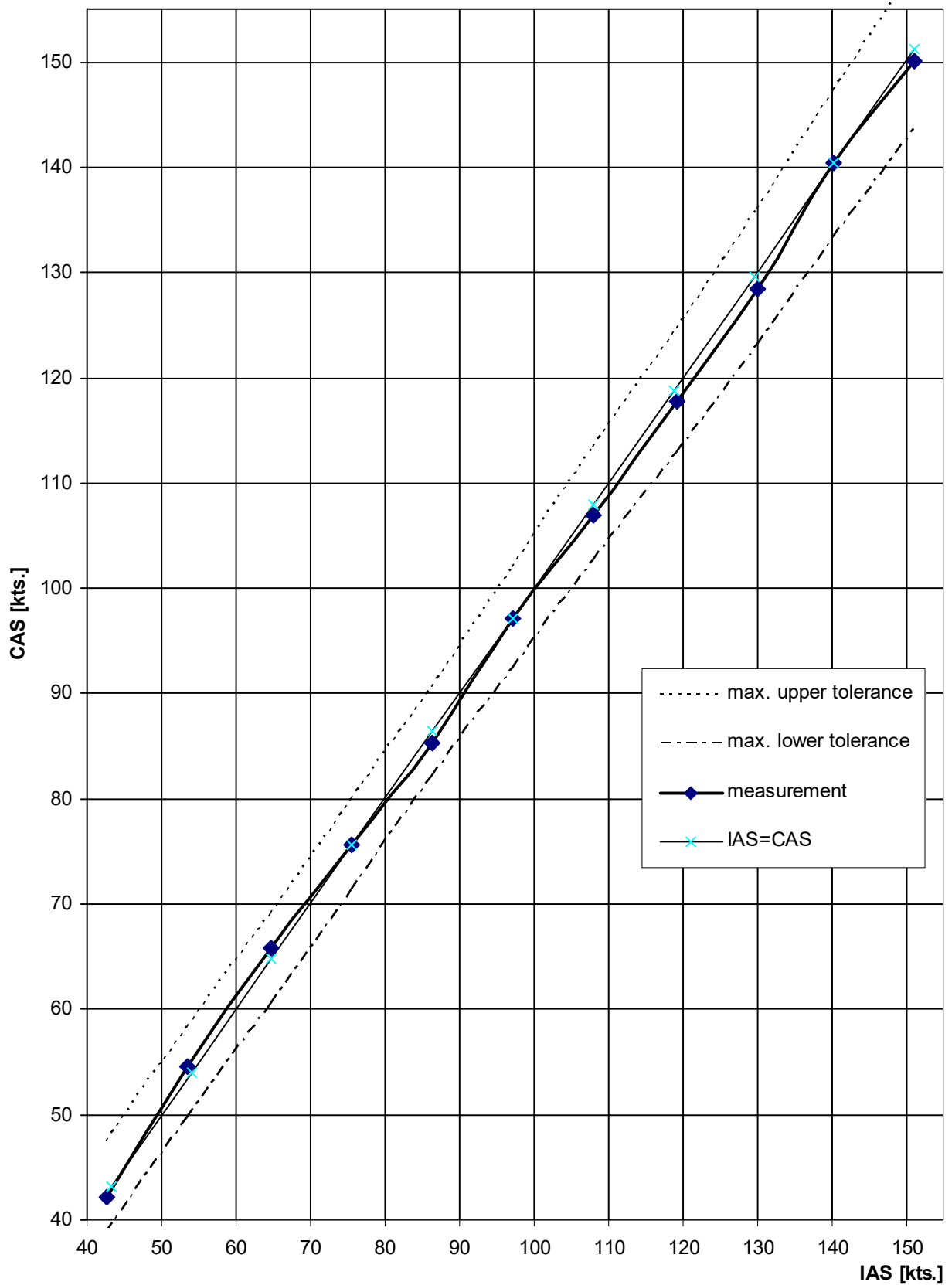

Flight Manual DG-1000M

5.2.2 Stall speeds

The given speeds are the minimum achievable speeds during level flight in km/h and (kts.).

Note: the stall speeds given in the table have been determined by reducing the airspeed very slowly (quasistationary). With faster speed reduction as given in the airworthiness requirements, stall speeds will be lower.

Airbrakes retracted

mass kg	470	500	550	600	650	700	750	790
mass lbs	1036	1102	1213	1323	1433	1543	1653	1742
W/S kg/m ²	26.8	28.5	31.4	34.2	37.1	39.9	42.8	45.1
W/S lbs/ft ²	5.49	5.84	6.43	7.01	7.59	8.18	8.76	9.23
V km/h	61.7	63.6	66.8	69.7	72.6	75.3	77.9	80.0
V kts	33.3	34.4	36.0	37.6	39.2	40.7	42.1	43.2

Airbrakes extended

mass kg	470	500	550	600	650	700	750	790
V km/h	64.9	66.9	70.2	73.3	76.3	79.2	81.9	84.1
V kts	35.0	36.1	37.9	39.6	41.2	42.7	44.2	45.4

The loss of height for stall recovery is approximately 50 m (160 ft) if recovered immediately.

Flight Manual DG-1000M

5.2.3 Take-off performance

The data is valid for take-off from dry level hard surface, no wind and proper condition of engine, propeller and aircraft.

The take-off procedure is to be executed according to 4.5.2.

SR = take-off roll

S= take-off distance to 15 m (50 ft.) altitude

T = temperature on ground

H = pressure altitude, can be computed as follows:

$$H \text{ (m)} = (1013 \text{ mb} - \text{QNH}) \cdot 100 / 11.7 + \text{airfield elevation (m)}$$

mass [kg]		790		735		680	
H [m]	T [°C]	SR [m]	S [m]	SR [m]	S [m]	SR [m]	S [m]
0	0	264	419	216	342	174	275
	15	302	479	247	391	198	315
	30	343	544	280	444	225	357
500	0	298	472	243	386	196	310
	15	340	540	278	441	224	355
	30	386	613	316	501	254	403
1000	0	336	533	274	435	221	350
	15	384	609	314	497	252	400
	30	436	691	356	565	286	454
1500	0	379	602	310	492	249	395
	15	434	688	354	562	285	452
	30	492	781	402	638	324	513
2000	0	429	681	351	556	282	447
	15	491	778	401	636	322	511
	30	557	883	455	722	366	581
2500	0	486	771	397	630	320	507
	15	556	882	454	720	365	579
	30	631	1001	516	818	415	658
3000	0	552	875	451	715	363	575
	15	631	1001	515	817	415	657
	30	716	1136	585	928	471	746

Dry level grass surface increase the take-off distance by 10% to 15%.

Warning: Wet soft grass surface and / or cross wind may increase the take-off distance much more

Flight Manual DG-1000M

Take-off performance, British, US

mass [lbs.]		1742		1620		1499	
H [ft]	T [°F]	SR [ft]	S [ft]	SR [ft]	S [ft]	SR [ft]	S [ft]
0	32	867	1375	708	1123	570	904
	59	991	1572	810	1284	651	1033
	86	1125	1784	919	1458	739	1172
1000	32	932	1478	762	1208	613	972
	59	1065	1690	870	1381	700	1110
	86	1209	1918	988	1567	795	1261
2000	32	1003	1590	819	1299	659	1045
	59	1146	1818	936	1485	753	1195
	86	1301	2064	1063	1686	855	1356
3000	32	1079	1712	882	1399	709	1125
	59	1234	1956	1008	1599	811	1286
	86	1400	2221	1144	1815	920	1460
4000	32	1162	1843	950	1506	764	1211
	59	1328	2107	1085	1721	873	1385
	86	1508	2392	1232	1954	991	1572
5000	32	1252	1986	1023	1623	823	1305
	59	1824	2893	1490	2364	1199	1901
	86	2071	3284	1692	2683	1361	2158
6000	32	1350	2141	1103	1749	887	1407
	59	1543	2447	1261	1999	1014	1608
	86	1752	2778	1431	2270	1151	1826
7000	32	1456	2309	1190	1887	957	1518
	59	1664	2639	1360	2157	1094	1735
	86	1889	2996	1544	2448	1242	1969
8000	32	1571	2492	1284	2036	1033	1638
	59	1796	2848	1467	2327	1180	1872
	86	2039	3234	1666	2642	1340	2125
9000	32	1697	2691	1386	2199	1115	1768
	59	1939	3076	1584	2513	1274	2021
	86	2201	3492	1799	2853	1447	2295
10000	32	1833	2907	1498	2375	1205	1911
	59	2095	3323	1712	2715	1377	2184
	86	2378	3772	1943	3082	1563	2479

Flight Manual DG-1000M

5.3 Additional Information

5.3.1 Demonstrated crosswind performance

The demonstrated crosswind velocity is 15 km/h (8 kts) according to the airworthiness requirements.

5.3.2 Gliding performance

Performance data with 20 m span ($S = 17,53 \text{ m}^2$)

wing loading	kg/m ²	28	35	42	45
mass	kg	491	614	736	790
minimum sink		0.51	0.56	0.62	0.64
at	V [km/h]	79	88	98	102
best glide ratio		45.9	46.3	46.6	46.8
at	V [km/h]	93	104	120	125

wing loading	lbs/ft ²	5.73	7.17	8.60	9.22
mass	lbs.	1611	2015	2415	2592
minimum sink	ft/min.	100	110	122	126
at	V [kts.]	43	48	53	55
best glide ratio		45.9	46.3	46.6	46.8
at	V [kts.]	50	56	65	67

A variation in speed by $\pm 10 \text{ km/h}$ (5 kts.) from the above will decrease the best glide angle by 0.5 glide points and increase the min. sink rate by 1 cm/sec. (2 ft/min).

The polar curves can be seen on the next page.

For optimum performance, the aircraft should be flown with a C.G. towards the rear of the allowable range. This especially improves thermalling performance. However the aircraft will be more pitch sensitive.

The wing fuselage joint, wing parting and the tailplane fin joint should be taped up and the aircraft thoroughly cleaned to obtain maximum performance.

The polars apply to a "clean" aircraft.

With dirty wings or flight in rain, the performance drops accordingly.

Flight Manual DG-1000M

Flight polar with 20 m wing span

1 kts= 1 km/h / 1.852, 1 m/s= 197 ft/min.= 1.94 kts, 1 kg/m²= 0.2048 lbs/ft²

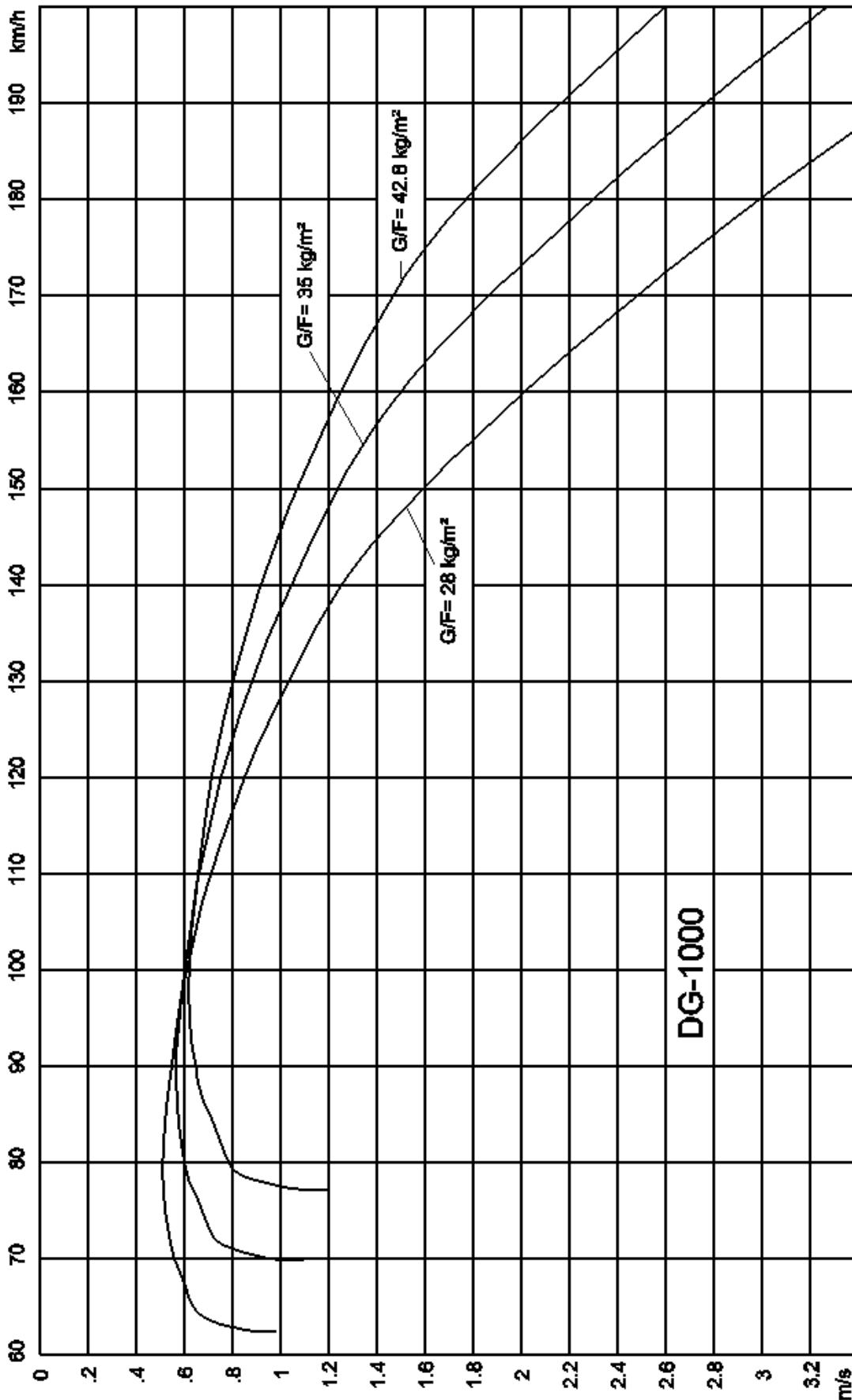

Flight Manual DG-1000M

5.3.3 Performance under power

5.3.3.1 Rate of climb

Measured rates of climb for 15°C (59°F) at MSL.

15°C increase in temperature reduces the rate of climb by ca. 0.2 m/s (40 ft/min.).

R/C = climb rate at $V_y = 95$ km/h (51 kts.) and with flap setting +8°

H = altitude above sea level

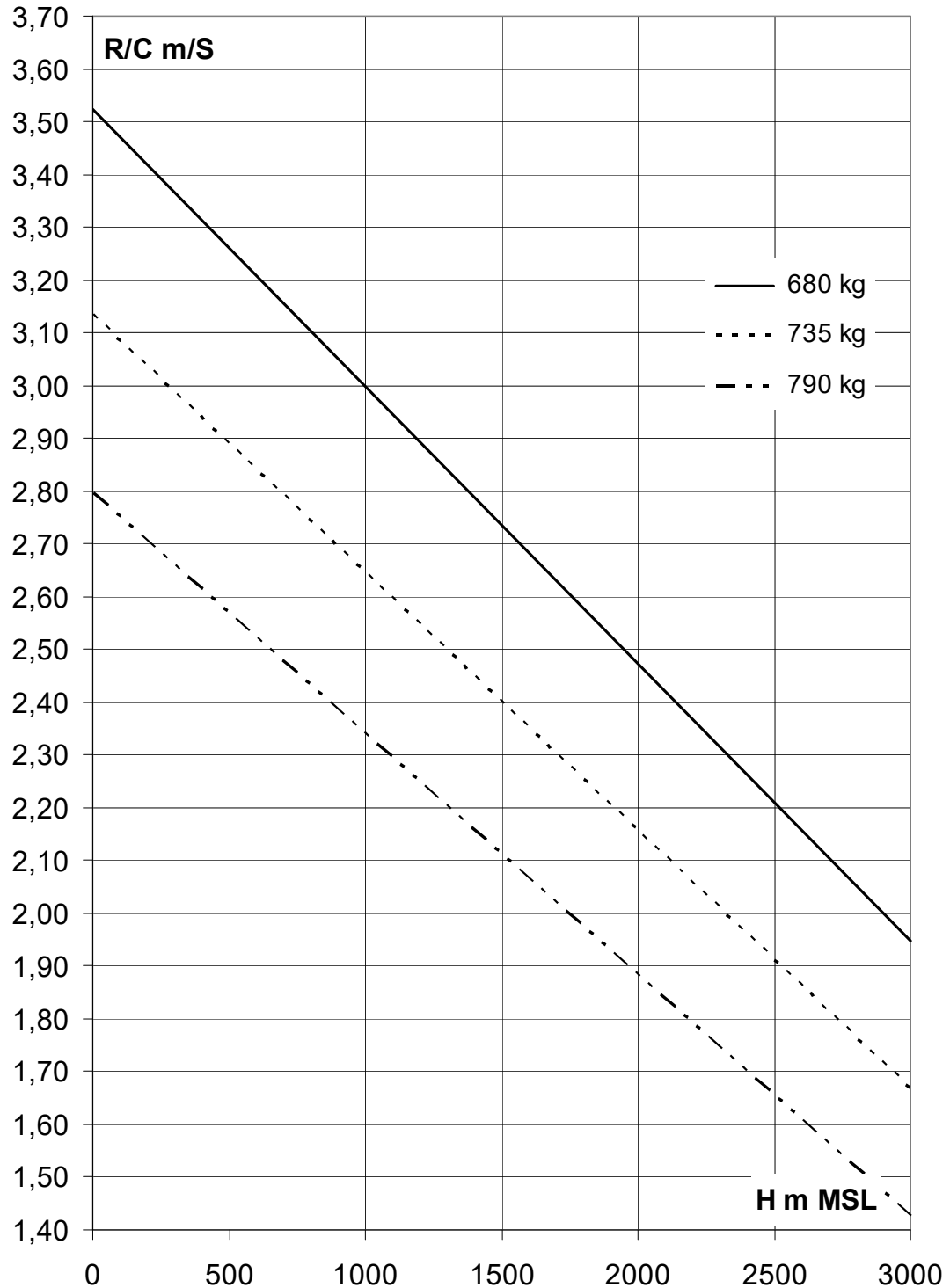

Flight Manual DG-1000M

Rate of climb British, US

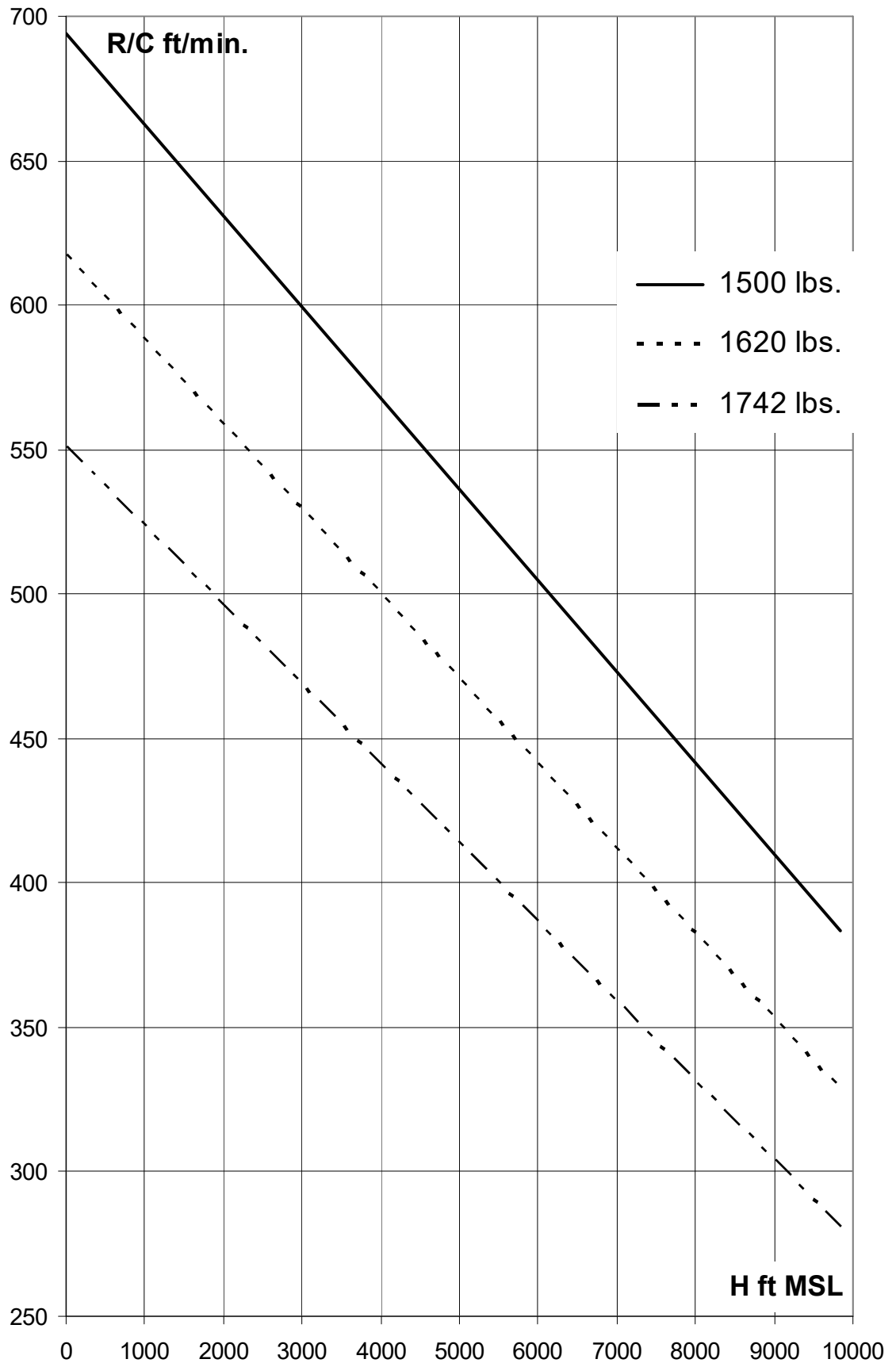

Flight Manual DG-1000M

5.3.3.2 Cruising Flight

The cruising speed is approx. 150 km/h (81 kts.) with the recommended engine speed of 6300 RPM.

5.3.3.3 Maximum operational altitude

The maximum operational altitude is more than 4000 m (13100 ft) MSL.
The engine

5.3.3.4 Maximum Range (without reserve)

Take-off mass 730 kg, 1609 lbs.

1. At cruising speed

with full fuselage tank (40 L, 10.6 US gal)=
approx. 270 km, 146 nm.

This is 6.8 km/L; 14 nm/US gal.

2. With saw-tooth flight technique Mc Cready O

with full fuselage tank (40 L, 10.6 US gal)=
max. 800 km; 430 nm.

This is 20 km/L, 40.5 nm/US gal

These values can only be achieved with still air and exact speed control.

3. With saw-tooth flight technique Mc Cready 1

with full fuselage tank (40 L, 10.6 US gal)=
max. 690 km; 370 nm.

This is 17.3 km/L, 35 nm/US gal.

The values for saw-tooth technique are for beginning the climb at 500 m (1640 ft) MSL and a climb of 1000 m (3280 ft).

5.3.4 Noise data

Noise requirements: ICAO Annex 16, Volume I, Part II, Chapter X

Measured noise level: 64.3dB(A) at 790 kg (1742 lbs.)

Noise limit: 75.1 dB(A) at 790 kg (1742 lbs.)

6 Mass (weight) and balance

Section	page
6.1 Introduction	6.2
6.2 Weighing procedures	6.2
6.3 Weighing record.....	6.2
6.4 Basic empty mass and C.G.....	6.2
6.5 Mass of all non-lifting parts (WNLP).....	6.3
6.6 Max. mass (weight).....	6.3
6.6.1 with waterballast:	6.3
6.6.2 without waterballast:	6.3
6.7 Useful loads.....	6.3
6.8 Loading chart.....	6.4
6.8.1 Cockpit load	6.4
6.8.2 Removable ballast for underweight pilots (Option).....	6.4
6.8.3 Baggage.....	6.5
6.8.4 Battery in the fin.....	6.5
6.8.5 Waterballast in the wing tanks (Option)	6.5
6.8.6 Section not effective.....	6.5
6.8.7 Ballast box in the fin	6.5
6.8.8 Weighing report (for section 6.3).....	6.7
6.8.9 Empty weight C.G. limits (for 6.4)	6.8
6.8.10 DG-1000 ballast chart (for 6.8.5).....	6.12
6.9 C.G. calculation.....	6.14

6.1 Introduction

This section contains the payload range within which the motorglider may be safely operated.

A procedure for calculating the in-flight C.G. is also provided.

A comprehensive list of all equipment available for this motorglider is contained in the maintenance manual.

6.2 Weighing procedures

See maintenance manual DG-1000M.

Datum: Wing leading edge at the root rib.

Reference line: aft fuselage centre line horizontal.

The weighing is to be executed with all watertanks and the fuel tank emptied, without ballast in the trim ballast boxes in the fin and in the cockpit (optional) and without fin battery Z110 (Option), powerplant retracted.

6.3 Weighing record

The result of each C.G. weighing is to be entered on page 6.7. If the min. cockpit load has changed this data is to be entered in the cockpit placard as well. When altering the equipment, the new data can be gathered by a C.G. calculation (see section 6.9).

The actual equipment list is enclosed in the maintenance manual or in the aircraft log.

6.4 Basic empty mass and C.G.

Actual data see page 6.7.

With the empty weight C.G. and the cockpit loads in the limits of the diagram in section 6.8.9.1 and if with max. cockpit load (see warning in section 2.8) 12 kg ballast are loaded in the fin ballast box, the in-flight C.G. limits will not be exceeded.

Note: For operation with the powerplant removed other empty mass C.G. limits are valid, see section 16.8.9.2.

For not exceeding the forward C.G. limits heavy pilots when flying the DG-1000M two-seated with powerplant removed must **not** necessarily compensate the mass of the front and the rear pilot according to section 6.8.7.2.

6.5 Mass of all non-lifting parts (WNLP)

The max. mass of all non-lifting parts is 600 kg (1323 lbs.).

WNLP is to be determined as follows:

WNLP = WNLP empty + load in fuselage (pilots, parachute, baggage, fuel, trim ballast, removable items of equipment etc.).

WNLP empty = Total empty weight incl. permanently installed equipment minus weight of the wings.

6.6 Max. mass (weight)

6.6.1 with waterballast:

Maximum take and landing off mass: 790 kg (1742 lbs.)

6.6.2 without waterballast:

Maximum take-off and landing mass = WNLP + Wwings

WNLP = Maximum mass of all non lifting parts (see above)

Wwings = actual mass of the wings

6.7 Useful loads

Max. load without waterballast

= max. mass without waterballast - empty mass

Max. load with waterballast

= max. mass with waterballast - empty mass

The data is recorded on page 6.7.

6.8 Loading chart

6.8.1 Cockpit load

see weighing report section 6.8.8.

a) single seated:

max. load in the front seat 110 kg (242 lbs)

min. load in the front seat see placard in cockpit and weighing report

b) two-seated:

max. cockpit load is 210 kg (463 lbs.) with a max. of 105 kg (231 lbs.) in the front seat or 110 kg (242 lbs.) in the front seat and 90 kg (198 lbs.) in the rear seat.

min. cockpit load in the front seat is the min. cockpit load see a) minus 40% of the load in the rear seat.

With these loads, the C.G. given under section 2.8 will be kept in the limits if the empty weight C.G. is in its limits and if with max. cockpit load two seated 12 kg ballast are loaded in the fin ballast box, see warning.

Warning: For not exceeding the forward C.G. limits when flying the DG-1000M two-seated, heavy pilots must compensate the mass of the front and the rear pilot according to section 6.8.7.

It is strongly recommended to perform a C.G. calculation according to section 6.9. For this calculation use the pilot C.G.'s marked with "v"

With lower pilot weight necessary ballast must be added in the seat or in the optional ballast boxes see below. Ballast put on the seat (lead ballast cushion) must be fastened at the connections of the safety belts.

6.8.2 Removable ballast for underweight pilots (Option)

Option: Ballast boxes in the front cockpit for removable Ballast (trim weights), see section 7.17.1.

6.8.3 Baggage

max. 15 kg (33lbs)

Heavy pieces of baggage must be secured to the baggage compartment floor (screwing to the floor or with belts). The max. mass secured on one half of the floor (left and right of fuselage centre line) should not exceed 7,5 kg (16.5 lbs.).

With the load added in the fuselage the max. load without waterballast (W.B.) (see weighing report section 6.8.8) must not be exceeded.

6.8.4 Battery in the fin

Only the use of the factory supplied battery Z110 (mass 5.5 kg, 12.1 lbs.) is permitted.

Only heavy pilots should install a battery in the fin.

The battery in the fin raises the min. front cockpit load by 16 kg (35 lbs.).

Note: The fin battery equals (concerning the C.G.) 39 kg pilot mass in the rear cockpit.

6.8.5 Waterballast in the wing tanks (Option)

The tanks have a capacity of 80 l (21,2 US gallons) per wing

The permitted amount of waterballast is dependent on the empty weight and of the load in the fuselage and can be determined from the diagram "Ballast chart" section 6.8.10.

It is only allowed to fly with symmetric wing ballast!

6.8.6 Section not effective

6.8.7 Ballast box in the fin

6.8.7.1 Compensation of the C.G. shift due to the rear pilot:

The ballast box can accommodate max. 4 weights of 2,4 kg mass (heavy weight) and 2 weights of 1,2 kg mass (light weight), so the max. mass is 12 kg.

The number of weights can be determined by the following table:

Mass of rear pilot		Number of trim weights	Number of blinks of the lamp in the front instrument panel see section 4.2.4
kg	lbs.		
55	121	2 heavy + 1 light	5
65	143	3 heavy	6
75	165	3 heavy + 1 light	7
85	187	4 heavy	8
95	209	4 heavy + 1 light	9
105	231	4 heavy + 2 light	10

Flight Manual DG-1000M

Warning: When flying solo the ballast box must be emptied, except see section 6.8.7.2! Otherwise you will fly with a dangerous C.G. position.

If the ballast box is filled up, the min. cockpit load in the front seat is raised by 35 kg (77 lbs.).

The resulting value (min. cockpit load in front seat from weighing without ballast + 35 kg) must be entered in the table on page 6.7 as value XX and also on the placard at the indication lights for the fin tank on the front instrument panel.

6.8.7.2 Trim-possibility for heavy pilots:

The ballast box may be used for this purpose too.

One trim weight of 1.2 kg raises the min. load in the front seat by 3.5 kg (7.7 lbs.).

One trim weight of 2.4 kg raises the min. load in the front seat by 7 kg (15.4 lbs.).

Example for combination of 6.8.7.1 and 6.8.7.2

(1 kg= 2.2046 lbs):

Min. cockpit load of the glider:	70 kg	permissible amount of trim weights
Mass of the front pilot:	84 kg	2 x 2.4 kg
Mass of the rear pilot:	65 kg	3 x 2.4 kg or 2 x 2,4 kg and 2 x 1,2 kg
Total amount of trim ballast:		12 kg

This means that the ballast box can be filled completely for this example. Higher pilot masses can't be compensated.

Caution: Heavy pilots when flying the DG-1000M two-seated must compensate the mass of the front and the rear pilot.

Don't exceed the max. mass of 790 kg (1742 lbs.).

Flight Manual DG-1000M

6.8.8 Weighing report (for section 6.3)

Distances in mm, masses in kg -- 25.4 mm = 1 inch / 1 kg = 2.2046 lbs.

Date of weighing:						
Executed by:						
Date of equipment list:						
Empty mass						
Empty mass C.G.						
Max. mass without W.B.						
Max. load without W.B.						
max. mass with WB						
max. useful load with W.B.						
min. cockpit load ZZ (kg)						
min. cockpit load YY (kg)						
min. cockpit load XX (kg)						
max. load in both seats *	210	210				
Inspector, signature, stamp						

W.B.= waterballast

ZZ= min. load in front seat for solo flying with fin ballast box empty and without fin battery.

YY= ZZ + 16kg= min. load in front seat for solo flying with fin ballast box empty with fin battery.

XX= YY+35= min. load in front seat for solo flying with fin ballast box filled with fin battery.

*with max. cockpit load 12 kg ballast must be loaded in the tail ballast box.

Weighing without battery in the fin, without waterballast and without fuel.

Weighing with powerplant installed and retracted.

6.8.9 Empty weight C.G. limits (for 6.4)

6.8.9.1 Empty weight C.G. limits with powerplant installed

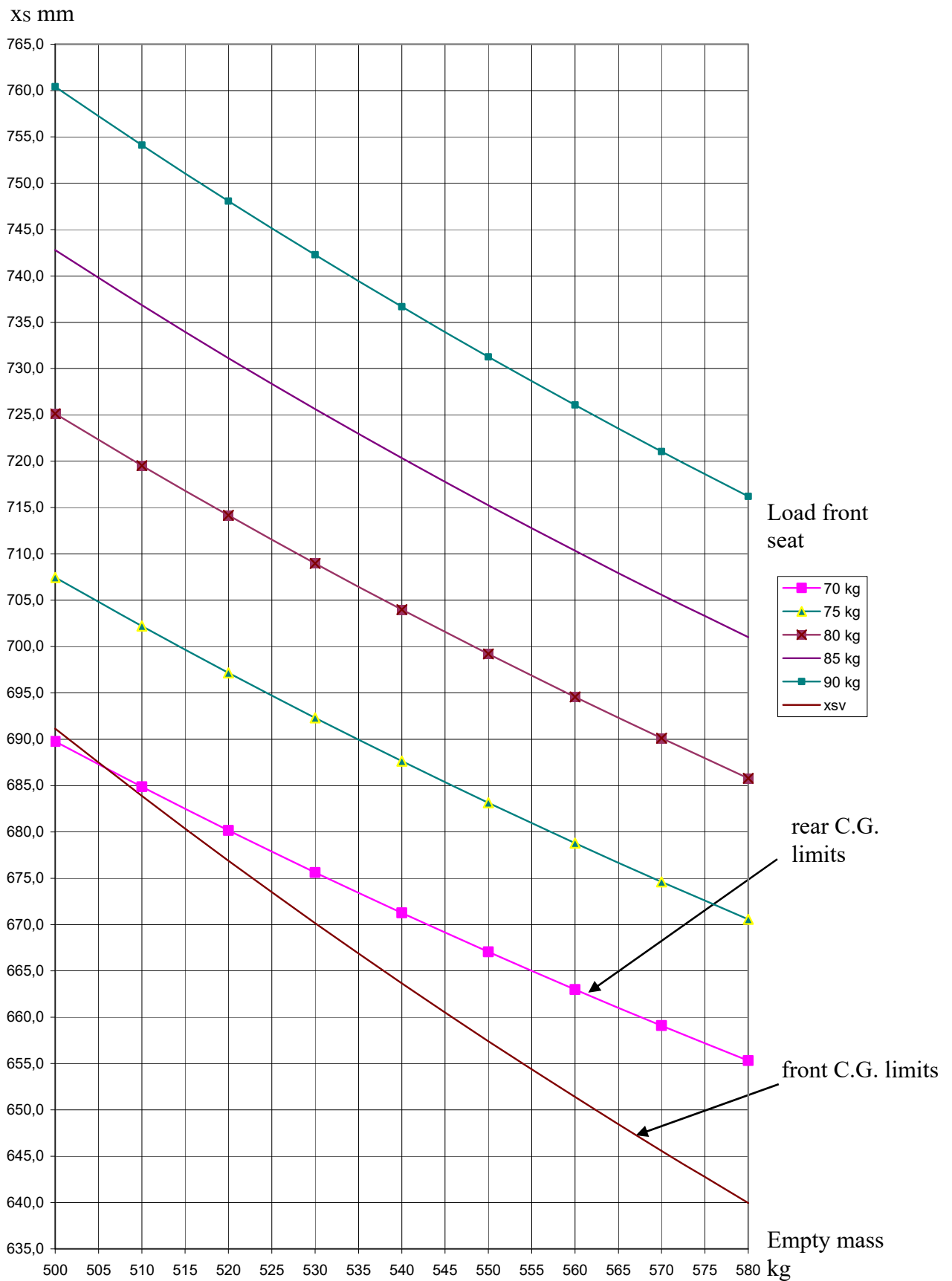

Flight Manual DG-1000M

Empty weight C.G. limits with powerplant installed British, US

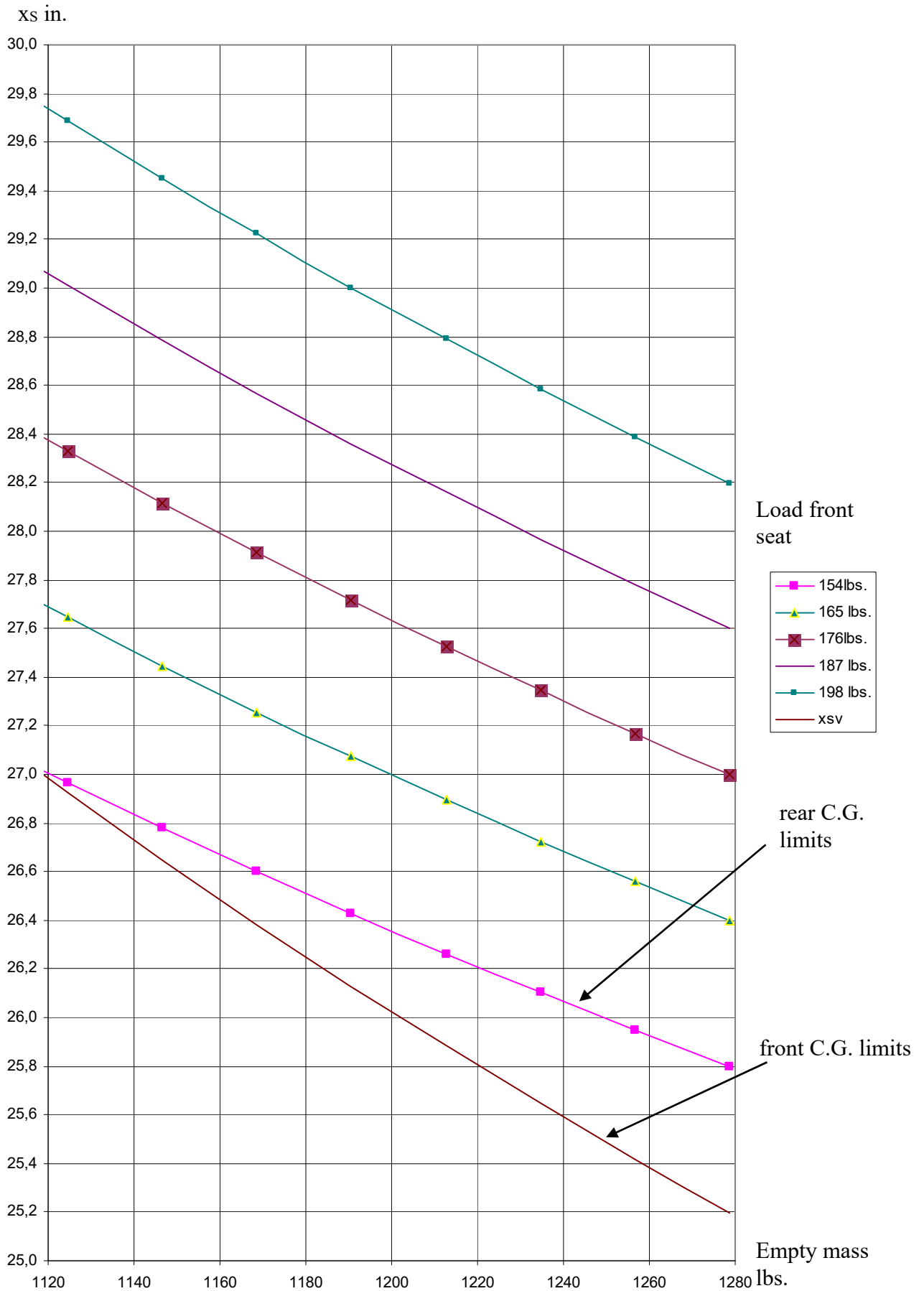

6.8.9.2 Empty weight C.G. limits with powerplant removed

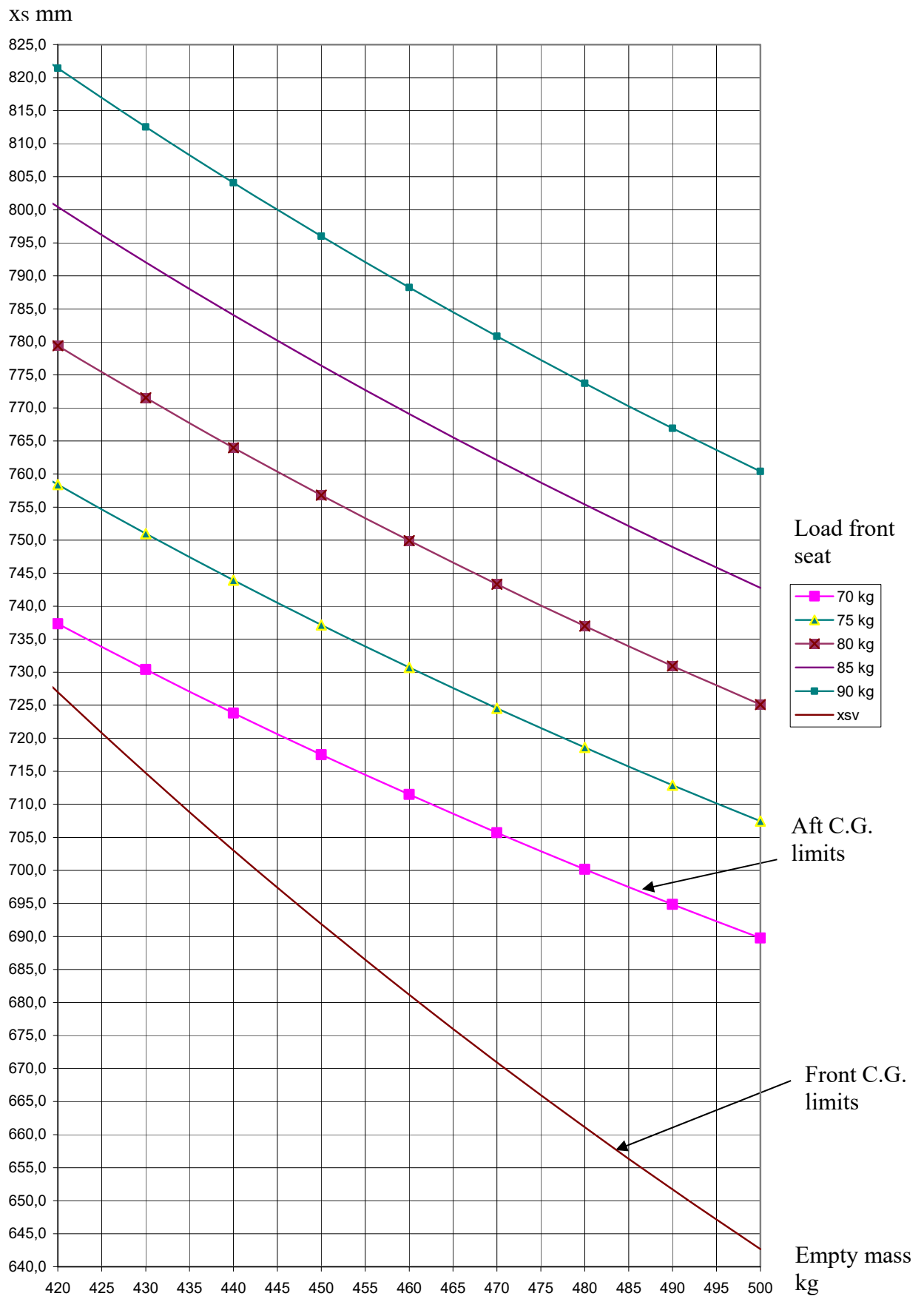

Flight Manual DG-1000M

Empty weight C.G. limits with powerplant removed British, US

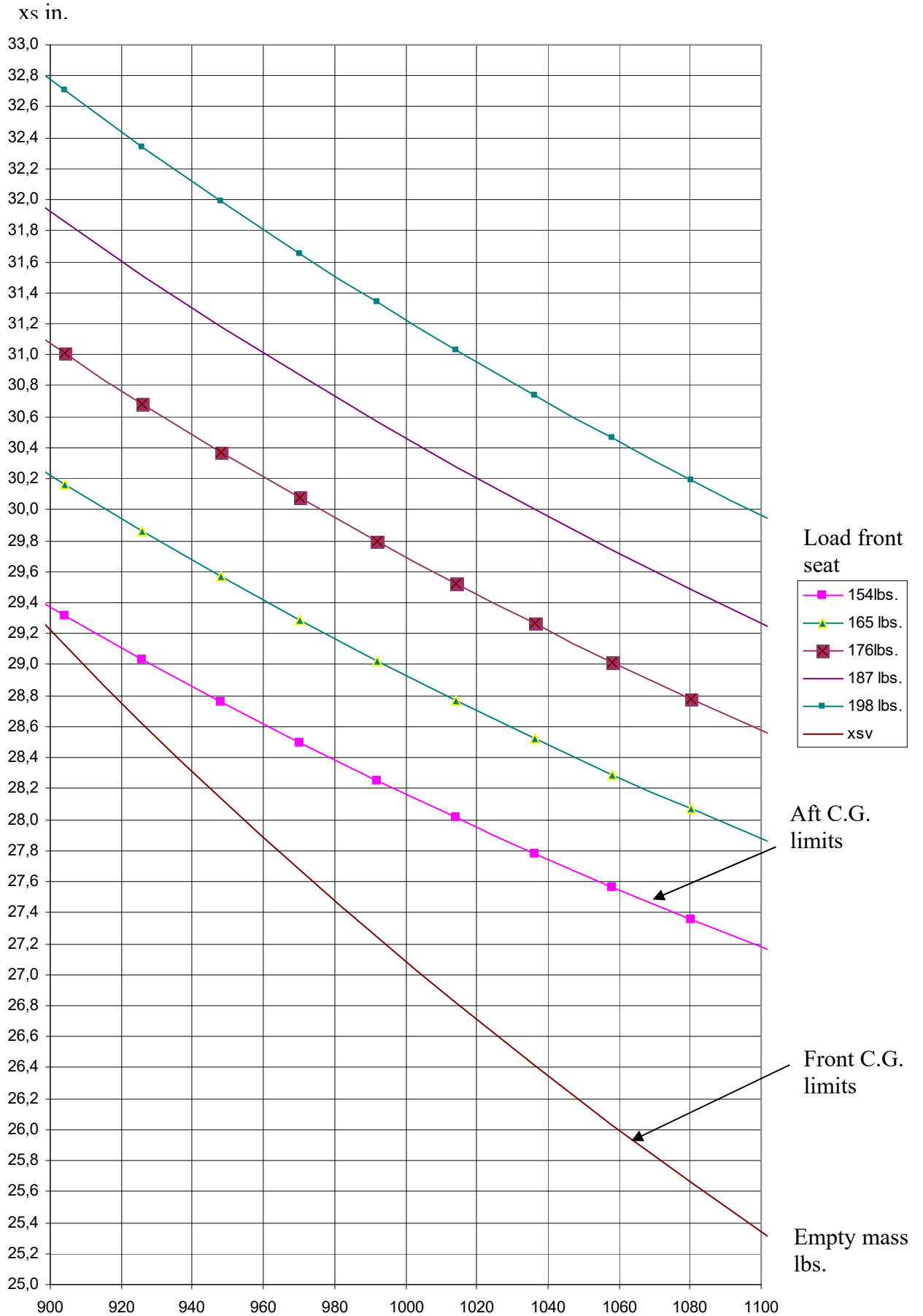

6.8.10 DG-1000 ballast chart (for 6.8.5)

To determine the max. allowable waterballast in the wing tanks for max. take-off weight 790 kg

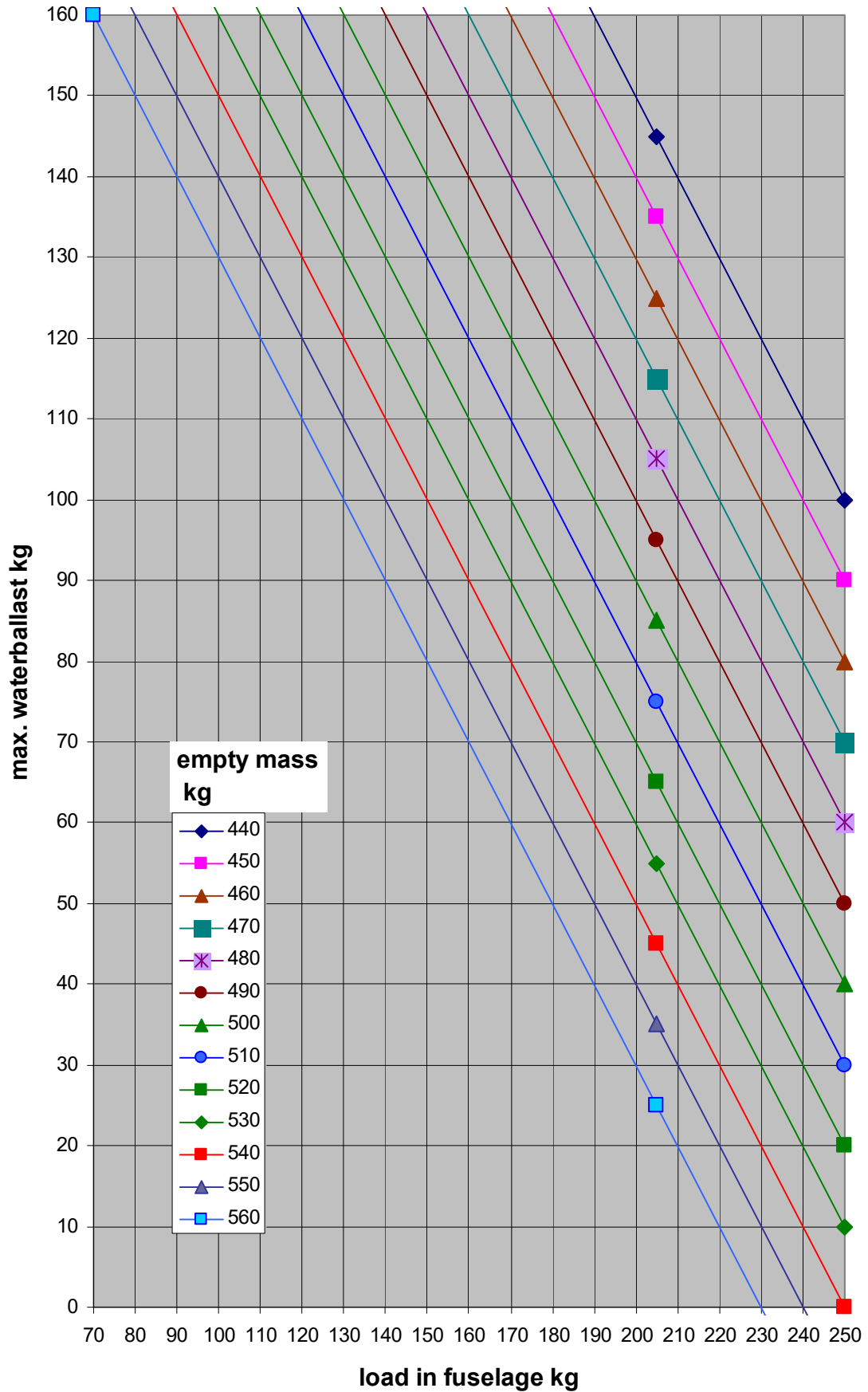

Flight Manual DG-1000M

DG-1000 ballast chart (for 6.8.5) British, US

To determine the max. allowable waterballast in the wing tanks for max. take-off weight 1742 lbs.

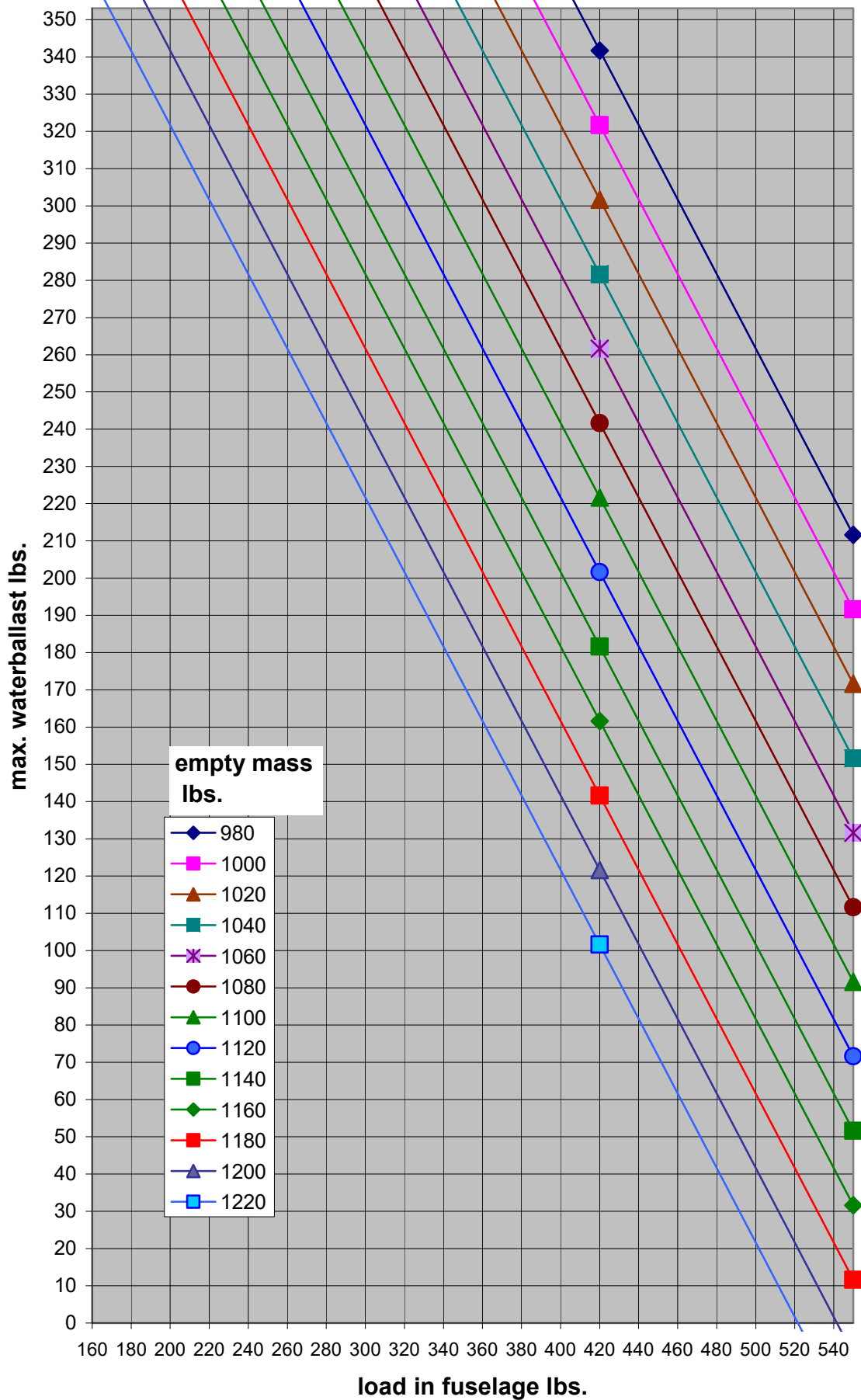

Flight Manual DG-1000M

6.9 C.G. calculation

The actual C.G. can be determined as follows:

For each item, the moment mass x C.G. has to be determined and to be added up and divided by the total mass. See the following example:

Item	mass		C.G. behind datum		moment	
	kg	lbs.	m	ft.	kg×m	ft.×lbs.
aircraft empty	530	1168.4	0.742	2.43	393.26	2844.5
front Pilot	105	231.5	-1.336	-4.38	-140.28	-1014.7
rear pilot	105	231.5	-0.273	-0.90	-28.67	-207.3
fuel	20	44.1	0.369	1.21	7.38	53.4
fin ballast	12	26.5	5.400	17.72	64.80	468.7
fin battery	5.5	12.1	5.340	17.52	29.37	212.4
Total	777.5	1714.1	0.419	1.38	325.87	2357.0

The limits of the in-flight C.G should not be exceeded:

Engine installed: 0.320m (12.6 in.) – 0.440m (17.32 in.)

Engine removed: 0.200 m (7.87 in.) – 0.440m (17.32 in.)

The most important C.G. positions (behind datum):

Pilot: The C.G. position is dependent on the pilot's shape, mass and thickness of the parachute. The pilot C.G. position can be determined by executing a weight and balance measurement with glider empty and equipped with the pilot etc. see maintenance manual. Please note, that the distance a has to be measured with both configurations, as it may change due to deflection of the landing gear.

The pilot C.G. can be determined by the following equation:

$$X_P = (X_{SF} * M_F - X_{SE} * M_E) / M_P$$

$$M_F = \text{flight mass} \quad X_{SF} = \text{flight C.G.}$$

$$M_E = \text{empty mass} \quad X_{SE} = \text{empty C.G.}$$

$$M_P = \text{pilot mass}$$

Flight Manual DG-1000M

If the actual pilot C.G. is not known, you have to take the values from the following table:

flight: v = near the forward C.G.
 h = near the aft C.G.

Pilot mass		Pilot C.G. lever arm							
		Front cockpit				Rear cockpit			
		v		h		v		h	
[kg]	(lbs.)	[m]	[in.]	[m]	[in.]	[m]	[in.]	[m]	[in.]
110	243	-1.388	-54.65	-1.335	-52.56	-0.317	-12.48	-0.272	-10.71
105	231	-1.390	-54.72	-1.336	-52.60	-0.318	-12.52	-0.273	-10.75
100	220	-1.391	-54.76	-1.337	-52.64	-0.319	-12.56	-0.274	-10.79
95	209	-1.392	-54.80	-1.338	-52.68	-0.320	-12.60	-0.275	-10.83
90	198	-1.393	-54.84	-1.340	-52.76	-0.321	-12.64	-0.276	-10.87
85	187	-1.395	-54.92	-1.341	-52.80	-0.323	-12.72	-0.277	-10.91
80	176	-1.396	-54.96	-1.342	-52.83	-0.324	-12.76	-0.278	-10.94
75	165	-1.397	-55.00	-1.343	-52.87	-0.325	-12.80	-0.279	-10.98
70	154	-1.399	-55.08	-1.344	-52.91	-0.326	-12.83	-0.280	-11.02
65	143	-1.400	-55.12	-1.345	-52.95	-0.328	-12.91	-0.281	-11.06
60	132	-1.401	-55.16	-1.346	-52.99	-0.329	-12.95	-0.282	-11.10
55	121	-1.402	-55.20	-1.347	-53.03	-0.330	-12.99	-0.283	-11.14

Further C.G. positions:

Item	C.G. positions	
	m	in.
Baggage and battery in baggage compartment	0.270	10.63
Water ballst in the wings	0.206	8.11
Ballast box in the fin (see section 6.8.7)	5.400	212.60
Instruments in front panel	-1.910	-75.20
Instruments in rear panel	-0.740	-29.13
Removable ballast (in front cockpit, Option, see section 7.17.1)	-1.960	-77.17
Battery in fin (Option see section 6.8.4)	5.340	210.24
Powerplant (see section 4.6)	1.261	49.65
Fuel tank	0.425	16.73

C.G. Shift due to extension of the engine

$$XS2 = XS1 - 3.8/W$$

- W = total mass (kg)
- XS2 = C.G. position with engine extended (m)
- XS1 = C.G. position with engine retracted (m)

Flight Manual DG-1000M

7 Motorglider and systems description

Section	page
7.1 Introduction	7.2
7.2 Airframe	7.2
7.3 Cockpit, cockpit controls and placards	7.3
7.4 DEI-NT Operation.....	7.11
7.4.1 Gliding and powered flight screens	7.11
7.4.2 Flight log	7.13
7.4.3 Set up screen (menu).....	7.15
7.4.4 Operating times	7.13
7.4.5 Display of powerplant failures and warnings	7.16
7.4.6 Flightlog → PC:	7.20
7.4.7 DEI-NT in the rear cockpit (Option).....	7.20
7.5 Flight controls	7.21
7.6 Airbrakes	7.21
7.7 Landing gear.....	7.22
7.8 Tow hooks	7.24
7.9 Seats and safety harness	7.24
7.10 Baggage compartment.....	7.24
7.11 Waterballast system (Option).....	7.24
7.12 Ballast box in the fin	7.24
7.13 Powerplant/fuel system	7.25
7.14 Electrical system	7.26
7.15 Pitot and static system.....	7.28
7.16 Canopies	7.28
7.17 Miscellaneous equipment (Options)	7.29
7.17.1 Removable ballast for under weight pilots	7.29
7.17.2 Oxygen system	7.29
7.17.3 ELT Emergency Locator Transmitter	7.29
7.17.4 Transponder.....	7.29
7.17.5 Battery in the baggage compartment with battery selector switch ..	7.30
7.17.6 Battery in the fin.....	7.30
7.17.7 Radio installation with automatic commutation	7.30

Flight Manual DG-1000M

7.1 Introduction

This section provides description and operating of the motorglider and its systems.

M.M. = Maintenance manual

Refer to section 9 "Supplements" for details of optional systems and equipment.

7.2 Airframe

The DG-1000M is a two-place high performance motorglider with 20 m span and permanently installed winglets

Construction

Wings	CFRP-foam-sandwich-shell with CFRP-roving spar caps
ailerons	CFRP-foam-sandwich-shell
Rudder	GFRP-foam sandwich-shell
Horizontal stabilizer	GFRP-foam sandwich-shell with CFRP-roving spar caps
Elevator	GFRP-shell
Fuselage	GFRP-shell, fuselage boom sandwich-shell with Tubus core, Carbonfibre reinforcement in engine bay area

Canopy

Two canopies hinged at the right hand fuselage side.

Canopy transparencies made from Plexiglas clear GS 241 or optionally green GS Green 2942.

Tailplane

T-Tail with conventional stabilizer-elevator and spring trim.

Colours

Airframe: white
registration numbers: grey RAL 7001 (Pantone 444)
or red RAL 3020 (Pantone 485)
or blue RAL 5010 (Pantone 301)
or blue RAL 5012 (Pantone 307)
or green RAL 6001 (Pantone 349)
or similar colours

7.3 Cockpit, cockpit controls and placards

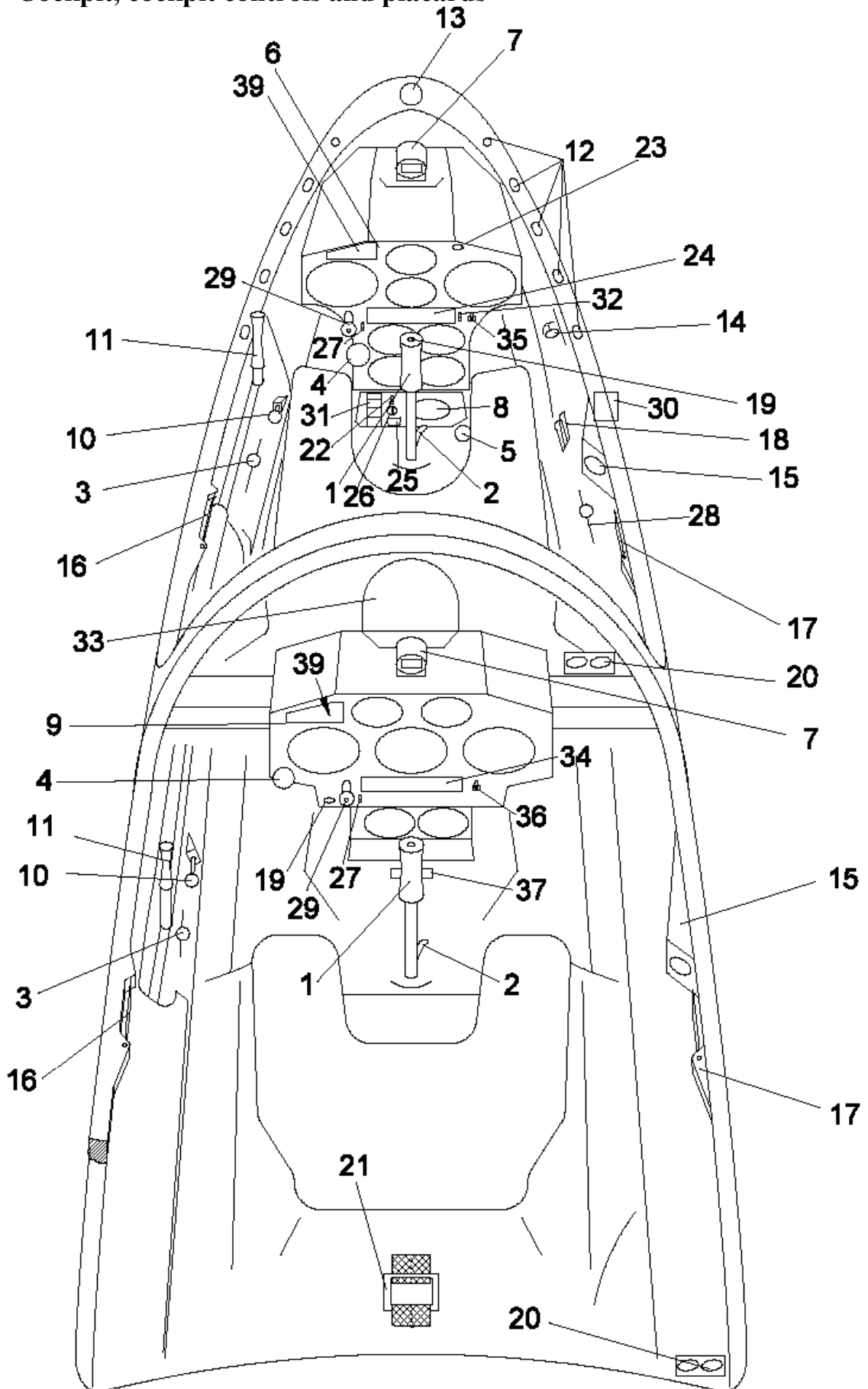

Flight Manual DG-1000M

1) Control column (in both cockpits)

The rear control stick is removable. First open the snap shackle at the trim release lever to disengage the trim cable. Pull out the stick after unscrewing the cap nut.

2) Release lever for the trim mechanism (in both cockpits) - green

Operation see section 7.5 elevator control

3) Trim position indicator and trim preselection lever (in both cockpits)



4) Tow release knob – yellow (in both cockpits)



5) Rudder pedal adjustment knob – black
(only in front cockpit)

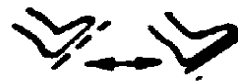

By pulling on the knob, the locking pin will be disengaged and the rudder pedals can be pulled back towards the pilot or pushed forward away from the pilot.

6) Front instrument panel

After removing the side screws at the base 2 x M 6 and after removing the screws attaching the cover to the panel 6 x M 4, the cover can be removed towards the front. The panel remains in the aircraft.

7) Compass installation position (in both cockpits)

8) Radio installation position

9) Rear instrument panel

After removing the side screws attaching the panel to the cover (4 x M 4) the panel can be hinged backwards into the cockpit (take out the control stick first!).

Flight Manual DG-1000M

- 10) Landing gear emergency extension handles (in both cockpits) - black-red
For emergency extension pull on one of the 2 red emergency extension handles, pull the handle until the landing gear is fully extended.

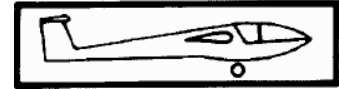

- 11) Airbrake handle (in both cockpits) - blue
The wheel brake is operated at the end of the airbrake handle travel.



Parking brake combined with an airbrake securing device (Piggott-hook): Pull the airbrake handle back to actuate the wheelbrake and rotate the handle to the cockpit wall. A detent will engage in one of 4 notches to hold the system in this position.

In case the airbrakes mistakenly haven't been locked, a detent engages in one of several notches to avoid inadvertent deployment of the airbrakes. To open and to close the airbrakes the operating handle must be rotated into the cockpit so far that the detent passes the notches.

- 12) Constantly open de-misting air vents

- 13) Main air vent

- 14) Main air vent operating knob
pushed to front = closed
pulled = open

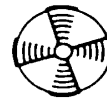

- 15) Swivel air vents (in both cockpits)

- 16) Canopy opening handle
(in both cockpits) - white-red
towards the nose = closed
into cockpit = open

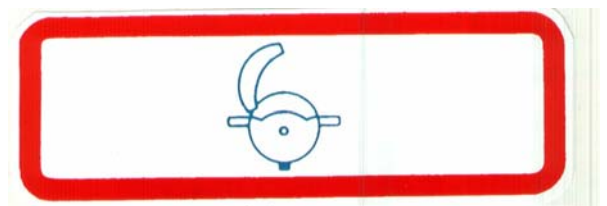

- 17) Canopy emergency release handle
(in both cockpits) - red
towards the nose = closed
into cockpit = open



For emergency release also handle 16 has to be operated!

Flight Manual DG-1000M

18) Water ballast dump handles - silver

Rotate backward to dump.

- upper handle = right wingtank
- lower handle = left wingtank
- forward = valve closed
- into the cockpit = valve open



19) Push to talk button (Option) (placard only if installed in the instrument panel)

20) 12 V socket for charging the batteries and socket for headset (Option), front and rear cockpit.

**Senden
transmit**

21) Adjustment strap for the rear seat shell (to be operated on the ground)

22) Selector switch for additional batteries (Option),

- up = internal battery
- centre position = off
- down = additional batteries

**intern
off
extern**

23) Control light for the trim ballast box in the fin:

The control light in the front instrument panel starts blinking after each transaction with the weights. By counting the amount of blinks, the amount of ballast can be

determined. for a heavy weight 2 blinks appear and 1 blink for a light weight, this means 10 blinks if the box is filled up completely. After a pause of 2-3 seconds the blinking will be repeated etc.. The blinking can be stopped by pressing on the control light. Pressing again on the control light reactivates the blinking feature.

A switch will be operated by the locking pin of the ballast box cover.

As long as the switch is not closed, the control light for the ballast box will blink with doubled speed without interruption. The blinking can't be switched off by pressing on the control light.

**Trim-ballast box in the fin
Min. load in the front seat**

<input type="text"/> kg	<input type="text"/> kg
box empty	box filled

Flight Manual DG-1000M

- 24) DEI-NT in front cockpit with integrated ignition switch: Switching up the ignition (the toggle has to be pulled out for switching). raises the powerplant to its operating position automatically
Switching off the ignition: As soon as the propeller stopped from turning, the powerplant will be automatically retracted in a position where the propeller stopper moves forward in the propeller circle.
You may turn the propeller into the position for retraction (ignition switched off) by pressing the starter button.
As soon as the propeller is in the position for retraction (close to the stopper) the engine will retract by itself.
Description of the DEI-NT see section 7.4.

- 25) Socket for data download from the DEI-NT

- 26) Main switch (key switch)

Turn anticlockwise: off,

Turn clockwise first position: In this position the 12V socket is live for charging the battery-

Turn clockwise second position: on

With this main switch the complete electric power supply will be cut off.
After taking out the main switch key the motorglider can't be operated.



- 27) Manual retraction – extension switch for the powerplant (front and rear cockpit)

Any operation of this switch switches off the automatic extension-retraction system. Operation of the ignition switch reactivates the automatic system.

up = extension down = retraction.

Hold the switch until the extension procedure stops.

Caution: Extend the engine manually on the ground prior to take-off or for maintenance work.

Manual retraction only to be used in the air if the automatic system doesn't work. Make sure, that the propeller is vertical.

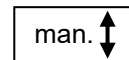

- 28) Fuel cock – red
to the front = open
to the rear = closed

Close the fuel cock only in an emergency (see chapter 3)

zu Brandhahn auf
closed fuel cock open

Flight Manual DG-1000M

- 29) Throttle handle with integrated starter button
(front and rear cockpit)

The starter button is only activated when the engine is extended and the ignition switch is in the "on" position.

With the engine running the starter motor will be blocked automatically.

Aligning the propeller for retraction with the starter button:

If after stopping the propeller is not in the retraction position, it is possible to turn the propeller slowly with the starter motor into retraction position by pressing the starter button (ignition switched off). The starter motor speed is reduced by electronic means during this procedure. This procedure should not be used on the ground so as not to unnecessarily stress the starter motor.

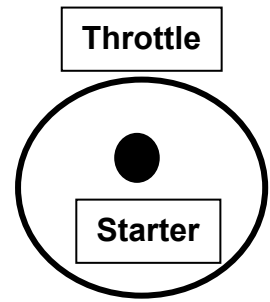

- 30) Rear view mirror to watch the propeller during aligning procedure
(front and rear cockpit)

- 31) Circuit breakers

Circuit breaker for the electric variometer	2A
Circuit breaker for the radio	3A
Circuit breaker spare	3A
Circuit breaker spare	3A

Note: Further fuses are located in the control unit. Those are re-settable fuses, except for the generator fuse (40A plug in fuse).

- 32) Change over switch from static pressure to total energy pressure for the variometers (Option).

up **stat** = Variometers operating on static pressure= for powered flight
down **T E** = Variometers operating on total energy probe= soaring flight.

- 33) Head rest for front pilot

The headrest may be screwed to the rear cockpit instrument cover in different longitudinal positions.

Flight Manual DG-1000M

34) DEI-NT in the rear cockpit with integrated ignition switch:

The ignition is only on and the powerplant will be extended, if the ignition switches in both cockpits are in the on position. As soon as 1 ignition switch will be switched off, the ignition is off and the powerplant will be retracted automatically.

This means, that for operation from the front seat the ignition switch in the rear cockpit must be always in the "on" position. For operation from the rear seat, the ignition switch in the front cockpit must be "on".

Caution: For flying with passenger it is necessary to secure the ignition switch in the rear cockpit with the securing plate. The securing plate is equipped with a quarter turn lock which must be operated with a screw driver.

For storage you may install the securing plate turned clockwise 90 °.

35) Emergency switch to switch over the engine control from the normal to the emergency system - red in the front instrument panel

up **normal** normal engine control via ECU

down **emergency** engine control via the emergency system

Note: In the emergency mode not all engine data will be displayed on the DEI-NT.

36) Option: Emergency switch to switch over the engine control from the normal to the emergency system - red in the rear instrument panel

up **normal** normal engine control via ECU

down **emergency** engine control via the emergency system

If one of the emergency switches is switched to **emergency** the engine control will be switched over to the emergency system.

For normal operation both switches must be in the **normal** position.

Caution: For flying with passengers etc. it is necessary to secure the emergency switch in the rear cockpit with the securing plate. The securing plate is equipped with a quarter turn lock which must be operated with a screw driver.

For storage you may install the securing plate turned anti-clockwise 90 °.

37) Fuse for the main battery 80 A in a recess below the carpets.

38) Not effective

Flight Manual DG-1000M

- 39) Control panel of the electrically operated main landing gear
(front and rear cockpit)

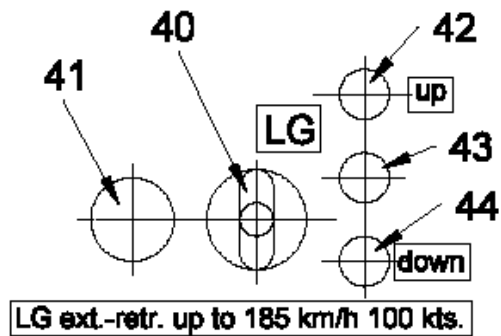

- 40) Toggle switch for extension and retraction of the electrically operated main landing gear
up retracted and locked
down extended
- 41) Press button for retraction of the electrically operated main landing gear
 To retract, switch and hold the toggle switch up and press the press button 2 times within 2 seconds.

- 42) – 44) control lights (LED's) for the electrically operated main landing gear:

Condition	control light indication
Normal operation	
LG retracted and locked	42) upper green shines
LG extended and locked	44) lower green shines
LG retracting	43) red shines, 42) upper green blinking
LG extending	43) red shines, 44) lower green blinking
LG stopped in intermediate position	43) red shines
Emergency operation	
LG extends	43) red shines
LG extended and locked	44) lower green shines, 43) red shines
System resetting	44) lower green shines, 43) red shines
Failure messages	
Time overflow: Signal appears if within 22 seconds after start of the travelling no limit switch activates	43) red blinking + upper or lower green blinking according to travel direction
One limit switch defective	all LED's blinking

Note: To save electrical power during flight the upper green LED will stop shining after approx. 5 minutes if the landing gear is retracted and locked.

7.4 DEI-NT Operation



After turning on the main switch the DEI-NT shows a screen with operating times.

Then the screen changes to the gliding screen (powerplant retracted) or to the powered flight screen (powerplant not retracted, limit switch not activated)).

You may change to other screens by pushing the selector knob (right hand side) until the DEI_NT beeps twice.

The following screens may be selected:

1. Gliding or powered flight (according to powerplant position)
2. Flight log
3. Set up
4. Operating times

Caution: In case of powerplant failures and if warnings are necessary full screen messages are displayed. All messages may be verified by a short push to the selector knob (1 beep), the DEI-NT changes back to the normal screen.

Description of the screens:

7.4.1 Gliding and powered flight screens

- Upper left: Fuel level: If the fuel level falls short of approx. 4 litres the message "Low Fuel" will be displayed, after verifying this message "R" will blink.
- Lower left: Outside air temperature OA(T): When the OAT falls below 2°C the message "Water Freeze" will be displayed, after verifying this message the OAT display starts blinking. Exemption see 7.4.1.2 last item.
- Lower right: Battery voltage: Below a voltage of 11V the message "Low battery" will be displayed. After verifying this message, the voltage display starts blinking. Above a voltage of 14,7V message "Bat. OvrCh." will be displayed. After verifying this message the voltage display starts blinking.

Note: With battery voltage below 11 V the starter motor can not be activated.

7.4.1.1 Gliding screen

- Upper centre: Stall factor, see set up menu.
- Upper right: Time
- Lower centre: engine time for this flight



7.4.1.2 Powered flight screen

- Upper centre:
 - a) With the engine running the engine RPM will be displayed.

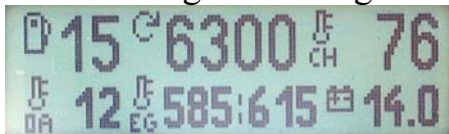

When exceeding the max. engine RPM the message "Engine Speed" will be displayed and the "Warning" symbol will blink, after verifying this message the RPM display is blinking.

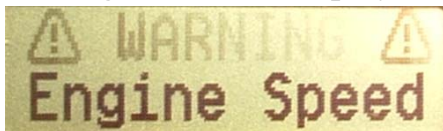

- b) As long as the engine is not running symbols showing the position of the powerplant will be displayed. In addition if the powerplant is moving, an arrow will be displayed showing if the powerplant is being retracted or extended (not when moving the powerplant via the manual switch). As soon as the powerplant is completely retracted (limit switch must be activated) the screen changes to the gliding screen. .
In case the propeller is not in the position for retraction a short propeller (side view) will be displayed. In position for retraction a long propeller will be displayed.

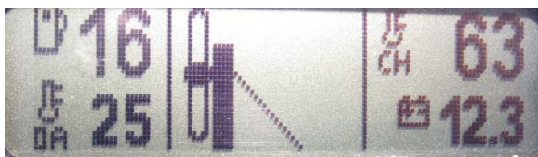

powerplant extended,
propeller in position for retraction



propeller not in position for retraction

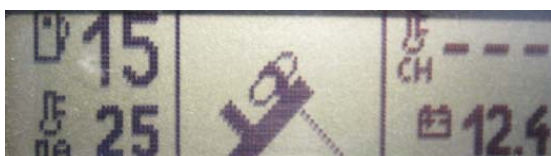

powerplant in position propeller stopper extended



propeller not in position for retraction propeller in position for retraction

Flight Manual DG-1000M

- c) When moving the powerplant via the manual switch, a hand symbol will be displayed showing that the automatic extension-retraction function is deactivated. Operating the ignition switch will reactivate the automatic extension-retraction function. The hand will disappear.

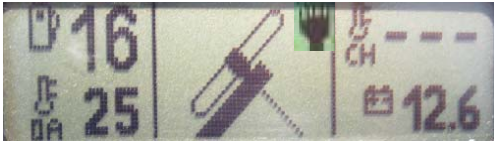

- Upper right: CH(T): Cylinder head temperature, above the max. certified CHT the message "CHT OverTemp " will be displayed, after verifying this message the CHT display is blinking.
The CHT will only be displayed with ignition on, otherwise "----" will be displayed..
- Lower left: If activated in the set up menu the slip ratio of the drive belts will be displayed in % instead of the OAT. Normal value 2- 4 % with constant engine RPM. With excessive slip the drive belts have to be tensioned. Varying slip may be an indication of a defective or incorrectly adjusted propeller sensor.
- Lower centre: EGT values: left= front cylinder, right= rear cylinder.

Further messages (Failure messages and warning messages) see section 7.4.5.

7.4.2 Flight log

The following data will be displayed:

Date, take-off time, landing time, engine time of this flight.

With the selector knob you may choose a flight. by a short push to the selector knob (1 beep) further data for his flight will be displayed: flight duration, max. engine RPM, max. CHT, max. EGT.

DATE	START	LANDG	MOT	DURATION:	
25.03	14:07	17:37	0:49	0:09	
24.03	--:--	--:--	0:00	MAX. RPM:	6010
				MAX. CHT:	61
				MAX. EGT:	725:720

7.4.3 Set up screen (menu)

On this screen 4 lines are displayed at a time, one of them is displayed negative and may be edited. Choose the line which is to be edited via the selector knob

Editing values: Push the selector knob (1 beep), and the first digit which may be edited will be displayed positive and may be altered via the

selector knob. Push the selector knob to confirm this value and you get to the next digit etc.. After confirmation the whole line will be displayed negative and you may select another line with the selector button.

SET TIME:	12:16
SET DATE:	30.03.2005
STARTER SPEED	37%
PRIMER DOSE	99%

Flight Manual DG-1000M

The following lines will be displayed:

1. RES. TRIP COUNTER: Push the selector knob, N (no) is pre-selected, rotate the selector knob Y (yes) will be displayed, push the selector knob to reset the time to zero.
2. RES. MAINT. TIMER: Push the selector knob, N (no) is pre-selected, rotate the selector knob Y (yes) will be displayed, push the selector knob to reset the time to the service-interval (25 hours).
3. FLIGHTLOG → PC: Push the selector knob, N (no) is pre-selected, rotate the selector knob Y (yes) will be displayed, push the selector knob to start the download of the recorded data. The PC must be connected to the serial interface (socket close to the radio). Flight log and service data will be downloaded (see section 7.4.6).
4. SET TIME: Set up time (HH:MM)
5. SET DATE: Set up date (DD.MM.YYYY)
6. STALL FACTOR: With this factor the start of the stall warning will be set (warning via a buzzer).

Adjustment may be made by flying level and gently stalling the glider to determine the stalling speed, then fly approx. 5% faster, note the displayed stall factor (upper centre display) and change the factor in the set up menu to this value. You have to make the adjustment for one operating condition only. The sensors for the stall warning make a quasi angle of attack measurement and thus the stall warning will work in other operating conditions too (different wing loading, turning flight, airbrakes extended etc.).

Caution: If the stall factor is set to 0.89 the stall warning is switched off completely. This setting is only allowed to eliminate a permanent stall warning in case a sensor fails. Send the DEI for repair to the manufacturer as soon as possible.

7. CALIBRATE FUEL G(auge): Calibration of the fuel gauge with empty tank. Push the selector knob, N is pre-selected, rotate the selector knob, Y will be displayed. Push the selector knob to execute the calibration.
8. SYSTEM SETUP ****: PIN- secured menu. Only for service by the manufacturer.
9. FREEZE WARNING: Activation (Y) or deactivation (N) of the warning message. You may deactivate this warning in case no watertanks are installed. When deactivated the OAT screen will still blink at temperatures lower than +2°C.
Deactivation and activation see above.
10. AUDIO ALARM: Activation (Y) or deactivation (N) of the alarm tone, except for the stall warning tone which can't be deactivated. Deactivation and activation see above.

Note: The signal for the stall warning will not be deactivated.

Flight Manual DG-1000M

11. DISPLAY SLIP: The slip ratio of the drive belts will be displayed in % during engine run. The calculation of the ratio is by comparing the propeller speed measured by the propeller sensor and the engine speed from the ECU. If this indication is deactivated (N) the OAT will be displayed instead on the lower left display. Deactivation and activation see above.
12. MAINSWITCH WARNING: Activation (Y) or deactivation (N) of the reminder to switch off the main switch. Deactivation and activation see above.
13. ENABLE FUEL PUMP: The fuel pump of the normal system may be deactivated for service work (N), normally Y.
Deactivate the fuel pump for any servicing work with empty fuel tank to prevent the pump from running dry which will cause damage to the pump!
Deactivation and activation see above.

Note: Deactivation only switches off the fuel pump for building up fuel pressure prior to activating the starter motor (with engine extended, not running and ignition on).

So in case the fuel pump is not enabled again, the engine will still start and run but starting may take somewhat longer.

14. PROP BRAKE: Activation (Y) or deactivation (N) of the electrical propeller brake (Option). Deactivation and activation see above.,

Note: If no electrical propeller brake is installed this function must be deactivated, otherwise failure messages will be displayed.

Push the selector knob until the DEI-NT beeps twice to leave the set-up screen.

7.4.4 Operating times

ENGINE TRIP: Trip counter for the engine time, reset in the Setup menu.

ENGINE TOTAL: Engine elapsed time counter, reset only by the manufacturer.

NEXT MAINTENAN.(ce) : The engine time until the next maintenance, reset in the Setup menu after completion of the 25 hour maintenance.

DEI Vx.x E-BOX Vx.x: Software versions of DEI-NT and control unit

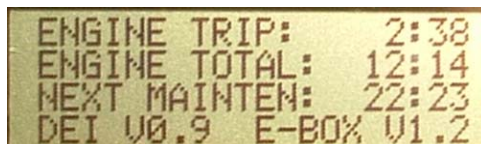

ENGINE TRIP: 2:38
ENGINE TOTAL: 12:14
NEXT MAINTEN: 22:23
DEI V0.9 E-BOX V1.2

7.4.5 Display of powerplant failures and warnings

In case of powerplant failures and if warnings are necessary full screen messages are displayed. All messages may be verified by a short push of the selector knob, the DEI-NT changes back to the normal screen.

Note: Most of the failure messages will no longer be displayed after verification, even if the failure shows up again in the same flight (e.g. loose contact). To display these messages for maintenance or repair work the main switch must be switched off and on again and the failure must be repeated, so normally you have to run the engine again until the failure occurs.

Caution: When switching over to the emergency system all failure messages of the normal engine control (ECU) will be eliminated to enable an undisturbed engine operation with the emergency system.. Failures which appear again during operation with the emergency system will be displayed again.

To display failure messages which have been displayed prior to switching over to the emergency system, the main switch must be switched off and on again, and the failure must be reproduced, e.g. by test running the engine.

7.4.5.1 Powerplant failures:

Upper line displays "Failure" and is blinking, 2. line displays the cause of the message:

1. "RPM Sensor" = The ECU will transmit no information about the engine speed to the DEI-NT, only speed measured by the Propeller sensor will be displayed. With such a failure the engine will quit immediately so that you have to switch over to the emergency instantly.
If this message is displayed, it is likely that the engine speed sensor or its wiring are defective and must be replaced.
 2. "Throt. Sensor " = failure of the potentiometer at the throttle valves. With such an error the ECU will select full throttle as intake value which means that further engine operation is only possible with full throttle.
 3. "Spindle Fuse" = the fuse for the spindle drive is blown -> wait until it cools down and resets (resets after approx. 10 seconds)
 4. "Water Pump" = Coolant pump or wiring defective. With this failure watch coolant temperature constantly and stop the engine as soon as possible.
 5. "Ignition 1" or "Ignition 2"= ignition circuit 1 or 2 defective.
- Note:** This message will also appear if during the ignition circuit check the switch is operated for more than 5 seconds.
6. "Fuel sensor " = Defect of one or both fuel level sensors or their wiring.

Flight Manual DG-1000M

7. "SpindleBrake" = With spindle drive motor on no power to its electric brake.
8. "Prop. Sensor" = Proximity switch or wiring defective, or switch not correctly adjusted -> automatic extension-retraction will be switched off, as the propeller position for powerplant retraction can't be detected safely. The slip indication won't work any more "---". .
9. "EGT Sensor" = One or both EGT sensors or their wiring are defective.
10. "CHT Sensor" = Cylinder head temperature (coolant) sensor defective. With such an error the ECU will select 69°C as intake value. This value will be displayed on the DEI. The ECU will not shut down the engine. As no warning in case of excessive CHT will occur, the failure must be fixed prior to the next engine operation.
11. "Refuel Pump" = Refuelling pump or wiring defective, displayed only with refuelling pump switched on.
12. "Fuel Pump" = Fuel pump or wiring defective, with engine running switch over to the emergency system if necessary.
13. "OAT Sensor" = Outside air temperature sensor or its wiring are defective.
14. "CBox Comm." = Disturbed data transfer between DEI-NT and control unit. The DEI-NT receives no information about powerplant position, propeller position etc. With engine not running you may try to solve the problem by switching off and on the main switch. With engine running proceed with the powered flight. Retract the powerplant via the manual switch in case the automatic retraction doesn't work. Don't use the starter motor!
15. "Generator" = Generator doesn't charge. Generator, regulator or regulator fuse (in control unit) is defective.
16. "IntakAirTemp" = Intake air temperature sensor or wiring are defective. With such an error the ECU will select 20°C throttle as intake value. The ECU will not shut down the engine, but operation will not be optimal.
17. "Prop Brake" = Motor of the electric propeller brake (Option) or wiring defective. Message only if propeller brake activated in the set up menu.

7.4.5.2 Warning messages:

Upper line displays "Warning " and is blinking, 2. line displays the cause of the warning:

1. "!!!Stall!!!" = Stall warning. To avoid messages during take-off and landing roll, this message is only activated at airspeeds above 60 km/h (32 kts.).
2. "Engine Slip": With excessive slipping of the drive belts (>15% for longer than for 10 seconds) the warning appears. The engine should be switched off as soon as possible and the failure should be fixed prior to the next engine operation.
3. "Fire": The probe is located near the intake funnels at the engine bay wall. In case of a fire the warning will appear if a temperature of approx. 140° C (284° F) is exceeded.
4. "Fuel Pressure": = Too low fuel pressure. This warning will appear either a) with engine extended not running and ignition switched on if the fuel pump is not able to build up sufficient fuel pressure within some seconds or b) if the fuel pressure drops below approx. 2.2 bar during powered flight. In this case the engine control should be switched over to the emergency system and.

Note: In case in the set up menu ENABLE FUEL PUMP N was set the warning will appear only with the engine running.

The failure should be fixed prior to the next engine operation.

5. "Engine Speed" = Engine RPM above max. certified value.
6. "CHT OverTemp" = CHT above max. certified value. Reduce engine speed or increase airspeed for better cooling. Check coolant pump.
7. "EGT OverTemp" = EGT above max. permissible value (>700°C). If the EGTs rise further switch over to the emergency system. The fuel pressure ECU and injection valves must be checked to solve the problem.
8. "Low Fuel" = Low fuel level, below approx. 4 Liters.
9. "Landg. Gear " = Landing gear warning when airbrakes are unlocked and the landing gear is still retracted. Warning appears only in flight.
10. "Canopy Open" = Rear canopy not locked, warning appears as soon as the front canopy is locked, but only with landing gear extended.
11. "Spoiler" = Airbrakes not locked, this warning is displayed at airspeeds above 45 km/h (24 kts.).
12. "Water Freeze" = OAT below +2°C. This warning appears only if activated in the set up menu.

Flight Manual DG-1000M

13. "Raise Gear" = Landing gear should be retracted, appears 8 minutes after take-off in case the landing gear is still extended.
14. "Starter Run" = Starter motor didn't disengage and is producing electric power, stop the engine immediately to prevent damage of the control unit. This message can't be erased by pushing the selector knob.
15. "CBox OvrTemp" = Starter motor control in control unit above temperature limit. If this warning appears don't operate the starter motor any more. If possible switch off the main switch.
16. "Battery Overch." = Battery voltage constantly above 14,9V.
17. "Low Battery" = Battery voltage below 11V for more than 30 seconds.

Caution: The starter motor control in the control unit will supply no electric power to the starter motor if the battery voltage is below 11 V prior to the starting attempt, starting is not possible!

18. "Main Switch" = Reminder to switch off the main switch.
 - With landing gear retracted (e.g. on the trailer after derigging) after 60 seconds.
 - With landing gear extended (e.g. in the hangar) after 5 minutes.In both cases time counts after the last operation of any item of the electrical system.
19. **Only with TNDG-G-09 executed:** "Open Fuel! " = Fuel cock not fully opened. Warning appears when ignition will be switched on.

7.4.5.3 Explanation for failure messages

Spindle Fuse:

The re-settable fuse for the spindle drive may be blown in the following cases:

- a) The propeller hub hooks during extension at the engine doors.
- b) The limit switch in position engine extended or retracted is not operated.

As soon as the fuse is blown the Control Unit changes to manual extension-retraction mode and thus cuts off power to the spindle drive and reports the failure to the DEI-NT.

After the cool-down time (approx. 10sec.) the message disappears and the symbol for manual operation (hand) will be displayed on the screen.

You may reactivate the automatic operation by operating the ignition switch, even during the cool-down time.

Case a) Retract the powerplant again manually, then try to extend the engine again.

Case b) Partially retract the engine manually and then try to extend the powerplant manually up to its operating position.

7.4.6 Flightlog → PC:

The following data may be downloaded:

Date, take-off time, landing time, flight duration, engine time, max. engine RPM, max. CHT, max. EGT of each flight; the duration of the max. values of engine speed and CHT have been over the limits; most of the “FAILURE” and WARNING” messages, which occurred during flight and their confirmation by the pilot.

The flightlog can store max. 250 flights. If this number is exceeded the oldest flights will be erased.

Download instructions can be found in the amendment to the maintenance manual.

7.4.7 DEI-NT in the rear cockpit (Option)

The DEI-NT in the rear cockpit is operated as a slave of the front DEI-NT. The functions and screens are similar to the front DEI-NT but no Flight log screen and no Set up screen and their functions are available.

7.5 Flight controls

7.5.1 Rudder control

See diagram 2 M.M

Cable system with adjustable pedals in the front cockpit.

7.5.2 Elevator control

See diagram 1 M.M.

All pushrods slide in maintenance free nylon ball guides.

Automatic control hook-up system. Spring trimmer with release lever at the control stick and control knob at the left cockpit wall. To trim, you have to operate the release lever at the control stick and place the control knob to the desired position.

7.5.3 Aileron control

See diagram 3 and 4 M.M.

Pushrods slide in maintenance free nylon ball guides.

Automatic control hook-up system.

7.6 Airbrakes

See diagram 3 and 4 M.M.

Double storey Schempp-Hirth type airbrakes on the upper wing surface.

The wheel brake is operated by the airbrake system.

Pushrods in the wings slide in maintenance free nylon ball guides.

Automatic control hook-up system.

7.7 Landing gear

7.7.1 Main landing gear

Very high electrically operated retractable main landing gear. Wheel spring-mounted with steel compression springs, with hydraulic disc brake, fully sealed landing gear box, see diagrams 7, 8 and 9 M.M,

In the normal operating mode the landing gear will be retracted and extended by an electrical spindle drive.

A control unit which is installed in the rear instrument tower controls all electrical functions and the control lights.

A landing gear warning device is integrated into the system.

Both cockpits are equipped with all controls and control lights

A manually operated emergency extension system is provided, see diagram 8 MM.

The landing gear will be pressed by the spindle drive against the stops in the extended position and held in this position.

The landing gear will be locked in the retracted position by 2 latches.

The system is equipped with a safety circuit against retraction of the landing gear on the ground see section 4.5.1.5.

The system is equipped with an over current cut off which stops the extension or retraction if high accelerations occur to protect the drive against damage. As soon as the g-loads lower, the landing gear will continue to travel.

Emergency operation: If the electrical system is damaged or no battery power is available, the landing gear may be extended manually. The handles are located at the left hand fuselage wall, one in each cockpit (at the positions of the handles for the manually operated landing gears). Pulling on one of the 2 emergency extension handles will open the valve of a lockable gas strut. The gas strut will push the spindle drive forward on a linear guide to extend and lock the landing gear.

Flight Manual DG-1000M

Technical data main landing gear:

Extension and retraction time (electrically operated): approx. 7seconds

Extension time emergency operation: approx. 2s

Power: 12V, max. 10 A

Tyre: 380 x 150 6 PR, diameter 380 mm (15 in.),
Wheel: Tost 5" wheel with disc brake Penta 130-30
Tyre pressure 3 bar (43 psi)

7.7.2 Tail wheel:

Steerable, linked with steel springs to the rudder, see diagram 10 MM.

Tyre: 200 x 50 6 PR, diameter 200 mm (7,87in.)

Wheel: Plastic hub with ball bearings part. No. S23

Tyre pressure 4 bar (58 psi)

7.8 Tow hooks

See diagram 5 M.M.

Safety release "Europa G 88" for winch launch installed near the C.G.

"nose release E 85" installed in the fuselage nose for aerotow.

Both hooks are operated by the same handles.

7.9 Seats and safety harness

The front seat is constructed as an integral inner shell.

The rear seat is height adjustable. The adjustment is by means of a strap similar to the shoulder harness.

As safety harness only symmetric 4-point harnesses fixed at the given fixing points are allowed.

7.10 Baggage compartment

Max. load 15 kg (33 lbs.).

Heavy pieces of baggage must be secured to the floor.

7.11 Waterballast system (Option)

See diagram 6 M.M.

The wingtanks are constructed as double wall bags with a capacity of 80 l per wing. The dump valves are mounted in the wings and the control is hooked up automatically when rigging the glider.

Filling is via the dump holes.

7.12 Ballast box in the fin

A box for ballast (trim-weights) is installed in the fin. It can be used to compensate the mass of the rear pilot and as a trim-possibility for heavy pilots.

Max. ballast capacity: 12 kg.

Filling see section 4.2.4, determination of the permissible amount of ballast see section 6.8.7.

Indication of the amount of ballast inserted is via a control light in the front instrument panel see section 4.2.4 and section 7.3 item 23).

7.13 Powerplant/fuel system

Powerplant see diagram 13 MM.

7.13.1 Engine

1. Type: See section 2.4.
2. The engine is mounted flexible to the propeller mast for vibration insulation.
3. Battery ignition with both normal and emergency systems.
4. Normal system: The engine is equipped with an electronic fuel injection system.

The engine control unit (ECU) controls the amount of fuel to be injected (1 injection valve per cylinder) in relation to the engine operational conditions and the flight altitude. The ECU controls the ignition coils of the dual ignition system.

5. Emergency system: In case the normal system fails an emergency system may be activated via a switch in the front instrument panel.

The emergency system is a simplified ECU which controls the amount of fuel to be injected (1 injection valve per cylinder) only in relation to the engine speed. The emergency system controls the ignition coils of the dual ignition system (same coils as for the normal system). The emergency system has its own injection valves and its own RPM sensor which gets its impulses from notches at the starter ring gear.

Note: The emergency system is designed for engine operation with max. power output as correlated to the throttle setting.

It won't work at conditions with throttle nearly closed e.g. cruise configuration or starting the engine, see section 3.15.

7.13.2 Propeller

Type: See section 2.4.

7.13.3 Reduction gear

Reduction gear with 5 high-tech V-belts. Reduction ratio approx. 1:2.8

7.13.4 Extension - retraction mechanism

System see diagrams 25 and 26 MM.

Electric spindle drive assisted by a gas-strut.

The opening and closing of the engine bay doors is automatic (see diagram 17).

7.13.5 Coolant system

System see diagram 14 MM.

Coolant pump: Electric pump, controlled via the ignition switch, installed at the engine.

7.13.6 Fuel system

System see diagram 16 MM.

7.13.6.1 Fuselage tank

40 l (106 US gal.) useable amount of fuel.

Two electric float gauges are installed in the tank to allow an indication which is almost independent from the pitch angle.

A switch located on top of the tank cuts off the electric power for the electric refuelling pump as soon as the tank is full.

7.13.6.2 Fuel pumps

1. Normal system: Electric pump, controlled via an automatic system in the control unit, installed in the fuselage centre section.
2. Emergency system: Electric pump, controlled via the ignition switch, installed in the fuselage centre section, in parallel to the pump of the normal system.
3. A refuelling pump is installed in the fuselage centre section. The refuelling hose with connector is located in the baggage compartment. The operating switch is mounted in the main bulkhead (rear cockpit left hand side).

7.14 Electrical system

See wiring plan 10E202.

7.14.1 On-board battery

A sealed maintenance free battery 12V/17Ah is installed in the foot of the rear instrument panel in the rear cockpit.

A fuse (80A) is installed in the positive wire behind the foot of the instrument panel in a recess in the cockpit floor under the carpet..

The engine is equipped with a Generator to charge the battery.

Recharging the battery with an automatic battery charger is possible via the 12 V sockets in both cockpits. Therefore the master switch must be in the first "charging" position.

7.14.2 Battery in the baggage compartment (Option)

See section 7.17.5

7.14.3 Battery in the fin (Option)

see section 7.17.6

7.14.4 All batteries

Warning: Use only automatic chargers designed to charge sealed lead acid batteries. To charge the battery to its full capacity a charger with 14.4 V max. charging voltage is necessary (normal automatic chargers charge only up to 13.8V). Such a charger is available from DG Flugzeugbau part no. Z 08.

7.14.5 Wiring

All current - carrying wiring conforms to aeronautical specifications.

7.14.6 Powerplant control and fuses

7.14.6.1 DEI-NT and control unit

The DEI-NT (digital engine indicator- new technology) and its control unit control all automatic and safety functions and displays the engine indications on digital displays. The control unit incorporates the master switch, the electronic starter motor control, extension- retraction relays, the regulator and fuses.

7.14.6.2 ECU and emergency system

The engine control unit (ECU) and the emergency system see section 7.13.1 are separate units which communicate with the control unit.

The control unit, the ECU and the emergency system are mounted in the compartment behind the wing spar connection.

Note: The powerplant control see section 7.14.5.1, the ECU, the emergency system, the ignition system, the fuel pumps of normal and emergency system, the coolant pump and both DEI's receive their electrical power in addition to the battery directly from the generator at the engine. So in case of a failure of the battery or when switching off the main switch the engine is able to continue running.

7.14.7 Electrically operated landing gear

Wiring see wiring plan 10E4 enclosed to the maintenance manual.

Fuses:

The electrically operated landing gear is protected by resettable fuse in the landing gear control unit.

Landing gear warning:

A landing gear warning device is integrated into the system. Warning is via the DEI-NT see section 7.4.5.

7.15 Pitot and static system

see diagram 11 M.M.

Pitot probe in fuselage nose, static ports a short distance behind fuselage nose. The airspeed indicator and the altimeter are to be connected to these ports and probe.

Probe (PC) for the stall warning device below the fuselage nose.

Additional holder for a TE-probe or a Multiprobe in the fin is to operate variometer and flight computer systems. To preserve the seals inside the holder, the end of the probe should be greased with e.g. Vaseline from time to time.

7.16 Canopies

To jettison the canopies in flight see section 3.2.

Removing a canopy:

Open the canopy, detach the retaining cable of the rear canopy and detach the gas strut from the front canopy. Then close the canopy and operate the red canopy emergency release handle (right) and the white-red canopy opening handle (left). Lift the canopy upwards.

Reinstalling a canopy:

Open emergency release and canopy locking levers. Place the canopy in vertical direction onto the fuselage. Close the emergency release. Open the canopy and snap in the retaining cable and the gas-strut.

Checking the canopy emergency release system:

- a) Check with open front canopy if the gas-strut can be disengaged from their ball fittings (from canopy and from fuselage). Grease the ball fittings, also of the gas strut of the rear canopy.
- b) Check with closed canopy if the emergency release handle can be operated and if the canopy can be removed easily, resp. if the canopy will be lifted by the gas-strut. Grease the locking pins.

7.17 Miscellaneous equipment (Options)

7.17.1 Removable ballast for under weight pilots

The ballast boxes (Option) at the right and left hand side of the instrument console underneath the carpets can accommodate 2 ballast weights of min 2.4 kg (5.3 lbs.) each. Each weight compensates a pilot mass of 3.2 kg (7 lbs.). So a max. of 12.8 kg (28 lbs.) missing pilot mass can be compensated.

The ballast weights are to be fixed in the box with a M8 knurled nut.

The ballast weights used for the ballast box in the fin may be used for these ballast boxes too.

7.17.2 Oxygen system

a) Installation of the oxygen cylinders

2 oxygen bottle of 3 l capacity with diameter 100 mm (3.94 in.) total length mm (in.) may be installed.

Installation places: One bottle in front of the rear seat and one bottle in the baggage compartment, see installation plan 5EP31 attached to the MM.

Installation is only approved using the equipment supplied by DG-Flugzeugbau GmbH..

Note: If an oxygen bottle is installed in the baggage compartment installation of a battery see section 7.17.5 and/or of an ELT see section 7.17.3 is not possible.

b) Installation of the oxygen system

To ensure a safe installation ask DG Flugzeugbau for an installation instruction.

For the installation of the Dräger Höhenatmer E 20088 you will find an installation plan 5EP31 in the maintenance Manual.

7.17.3 ELT Emergency Locator Transmitter

Installation see maintenance manual DG-1000M section 6.10.2.

7.17.4 Transponder

Installation see maintenance manual DG-1000M section 6.10.1.

Caution: The antenna wire must be installed during production of the aircraft, retrofit is not possible.

Caution: Concerning 7.17.2 up to 7.17.4

The installation has to be accomplished by DG-Flugzeugbau or by an approved service station and to be inspected and entered in the aircraft log book and released to service.

7.17.5 Battery in the baggage compartment with battery selector switch

An additional battery Z73/4 (sealed lead acid) or Z73/3 (LiFePO) with holder Z72 or Z01/7 (sealed lead acid) or Z01/5 (LiFePO) with holder Z200 (both batteries are available in may be installed in the baggage compartment.

In this case a battery selector switch must be installed in the front instrument panel.

Selector positions:

up = internal battery centre position = off down = additional batteries
Preferably the gliding computers and loggers shall be connected to this switch.

The battery fuse is installed at the battery, type: G fuse G 250 V 5 x 20 / 4 A fast.

Caution: It is not permissible to operate a LiFePO type battery in an electric circuit together with other batteries. Therefore you have to install at a suitable place in the cockpit a further selector switch to switch over from LiFePO battery to another battery or to the fin battery. This switch incl. wiring is included in the wiring plan 10E202 from issue h on (in aircraft log) named auxiliary battery selector.

7.17.6 Battery in the fin

A battery may be installed in the fin.

Section 4.2.5 and the loading chart see section 6.8.4 must be regarded.

Only the use of the factory supplied battery Z110 (12 V, min. 12 Ah, mass 5.5 kg (12.1 lbs.) is permitted.

The battery fuse is installed at the battery, type: G fuse G 250 V 5 x 20 / 4 A fast.

The wiring for this battery is in parallel to the battery in the baggage compartment.

7.17.7 Radio installation with automatic commutation

If the factory approved radio installation set is installed, the radio will be switched automatically from "normal" mode to "engine on" mode with the engine extended. With "normal mode" only the goose neck microphones are working.

With "engine on" mode the intercom system is working. Only the microphones of the headsets are working.

The loudspeaker and the speakers of the headsets are working together in both modes.

Note: Some modern radios (e.g. Becker AR 6201) enable operation of headsets with standard microphones together with the gooseneck-microphones which are equipped with dynamic microphones.

To use headsets with standard microphones one V-adaptor 10E109 must be installed per headset. In gliding mode the standard microphones of the headsets will not be switched off.

Flight Manual DG-1000M

8 Motorglider handling, care and maintenance

Section	Page
8.1 Introduction	8.2
8.2 Inspection period, maintenance.....	8.2
8.3 Alterations or repairs.....	8.3
8.4 Tie Down, Parking	8.3
8.5 Transport	8.4
8.6 Towing on the ground	8.4
8.7 Cleaning and Care	8.5
8.7.1 Exterior surfaces of the fibre-reinforced plastic parts.....	8.5
8.7.2 Plexiglas canopy.....	8.6
8.7.3 Metal parts.....	8.6
8.8 Power plant trouble shooting	8.7

Flight Manual DG-1000M

8.1 Introduction

This section contains manufacturer's recommended procedures for proper ground handling and servicing of the motorglider. It also identifies certain inspection and maintenance requirements which must be followed if the motorglider is to retain that new-plane performance and dependability. It is wise to follow a planned schedule of lubrication and preventive maintenance based on climatic and flying conditions encountered.

8.2 Inspection period, maintenance

The "Instructions for continued airworthiness" (maintenance manual) for the DG-1000M have to be followed.

- a) Before each rigging all the connecting pins and bushes should be cleaned and greased. This includes the control connectors.
- b) The contact surfaces of the canopies to the fuselage are to be rubbed with colourless floor-polish (canopy and fuselage side) to reduce grating noise in flight. Polish at the beginning of the flight season and then every month.
- c) Once a year all the bearings and hinges should be cleaned and greased. See the greasing programme of the maintenance manual.
Each year the control surface displacements, adjustments and general condition must be checked. (See the maintenance manual).

8.3 Alterations or repairs

It is essential that the responsible airworthiness authority be contacted prior to any alterations, to ensure that the airworthiness of the motorglider is not impaired.

It is prohibited to perform the alterations without approval of the airworthiness authority. The manufacturer will not be liable for the alteration or for damages resulting from changes in the characteristics of the aircraft due to alteration. So it is strongly recommended to execute no alterations which are not approved by the aircraft manufacturer.

External loads such as external camera installations are to be regarded as alterations! Repair instructions can be found in the DG-1000 repair manual. No repairs should be carried out without referring to the manual.

8.4 Tie Down, Parking

Run textile ropes or straps over the wing tips inboard of the winglets for tie down.

Alternatively you may use the holes in the wing tip wheel housings to install the ropes.

The fuselage should be tied down just ahead of the fin.

Water ballast can be left in the wings for a few days only, but not when there is the possibility of freezing! On sunny days the cockpit should be closed and covered.

Caution: Longer parking with exposure to sun and humidity will cause premature ageing of the external surfaces of your motorglider.

8.5 Transport

It is recommended to carry this valuable motorglider in a factory recommended closed trailer.

Approved fitting points:

Inner wing panels:

- Wing spar as close to wing root rib as possible or a root rib wing cradle.
- A wing cradle at the taper change.

Horizontal tailplane and outboard wing panel:

- Cradles as desired

Fuselage:

- A felt lined fibreglass nose cap which does not extend over the canopy, secured to floor.
- Fuselage dolly in front of the undercarriage
- Tail wheel-well in trailer floor. Secure fuselage with a belt in front of the fin or hold it down with the trailer top (soft foam in top).

All aircraft structures should not be subject to any unusual loads. With high temperatures that can occur inside trailers, these loads in time can warp any fibre reinforced plastic motorglider.

The trailer should be well ventilated so as to prevent moisture build up which could result in bubbles forming in the gelcoat. A solar powered ventilator is recommended.

8.6 Towing on the ground

- a) by towing from the nose hook using a rope with the standard double ring approved for the release
- b) by using a tow bar which is fixed to the tail dolly and a wing tip wheel.
- c) As it is difficult to move the DG-1000M backwards due to the steerable tailwheel a special fork Z202 to pull the fuselage out of the trailer and to pull the DG-1000M manually backward has been developed. It is available from DG Flugzeugbau.

The tow bar and wing tip wheel and the tail dolly may be ordered through the DG Flugzeugbau factory.

8.7 Cleaning and Care

8.7.1 Exterior surfaces of the fibre-reinforced plastic parts

The surfaces are coated by a UP-gelcoat or Polyurethane paint (Option). This surface is protected by a hard wax coating which has been applied during production with a rotating disc ("Schwabbel" procedure). Do not remove the wax, because this would lead to shading, swelling and cracking of the surface. In general, the wax coat is very resistant. As soon as the wax coat is damaged or worn, a new coat has to be applied (see maintenance manual sect. 3.1). If you store your aircraft often outside, this may be necessary every half year!

Hints for care

Wash the surface only with clean water using a sponge and chamois. Adhesive remains of tape may be removed with petroleum ether (pure petroleum spirit) which should be applied and removed immediately, otherwise this may lead to swelling of the gelcoat.

More stubborn dirt which cannot be removed by washing may be cleaned off with silicone-free, wax containing car polishes (e.g. 1Z Extra, Meguiars in USA).

Long-term dirt and shading can be removed by applying a new hard wax coat (see maintenance manual sect. 3.1).

Never use alcohol, acetone, thinner etc.. Do not use detergents for washing! Protect the surface from intense sunlight.

Protect the aircraft from water and moisture. See sections 8.4 and 8.5.

Remove water that has entered and allow the aircraft to dry out.

Never store your wet aircraft in a trailer.

Flight Manual DG-1000M

8.7.2 Plexiglas canopy

Use clean water and a chamois for cleaning.

Stubborn dirt and small scratches can be removed by use of the "Schwabbel procedure" (see maintenance manual sect. 3.1).

8.7.3 Metal parts

The pins and bushes for rigging the aircraft are not surface protected and must be covered with grease at all times.

Other metal parts, especially the control stick and all handles should occasionally be preserved with metal polishes.

8.8 Power plant trouble shooting

1a) **Extension and retraction doesn't work**

Spindle drive motor, brake of this motor, DEI-NT, control unit or wiring could be defective.

1b) **Automatic retraction doesn't work**

The propeller sensor (proximity switch) at the upper drive belt pulley or its wiring could be defective.

In case of loose contacts at the control unit, or broken wire or short circuit in the switch, the control unit switches over the retraction to the manual system and the DEI-NT displays the failure message "Prop.Sensor".

2. **Starter motor doesn't work**

Limit switch powerplant extended see maintenance manual section 1.13.5 does not work or starter motor or its wiring or control unit defective.

An indication for a defective control unit is the failure messages „CBox Comm“ or „CBox OvrTemp“.

Battery voltage too low: The starter motor control in the control unit will supply no electric power to the starter motor if the battery voltage is below 11 V prior to the starting attempt, the warning message "Low Battery" will be displayed in the DEI. Charge the battery.

Emergency procedure see flight manual 3.19.

3. **Engine doesn't reach ground test RPM**

- a. Dirt in the fuel filter, replace or clean the filter,
- b. Throttle butterfly valves doesn't open fully. Lubricate the Bowden cable or replace it if bent.
- c. Faulty ignition see item 5.
- d. Fuel lines clogged or kinked. Fuel filter clogged. Fuel pump defective. Check fuel pressure see maintenance manual sect. 3.6.1 item 3
- e. Air intake filter clogged, see MM section 3.6.1 item 5.
- f. EGT (exhaust gas temperature) too low. The adjustment must be done in the ECU and can only be performed by a service station trained and approved by DG Flugzeugbau.

4. **Loss of electrical power** see section 3.18.

Flight Manual DG-1000M

5. Ignition problems

No spark:

on 1 spark plug of one ignition circuit:

Spark plug, ignition cable or ECU or ignition coil defective.

on both spark plugs of one ignition circuit:

Too low starting RPM; weak battery; ECU or ignition coils defective.

on any of the spark plugs:

too low starting RPM., weak battery;

wire defective, ECU or ECU RPM sensor defective.

With all failures see above check if these failure will also occur with the emergency system. If the failure occurs only with the normal system, the failure is in the ECU or its wiring.

6. Engine becomes too hot

Fuel lines clogged, Fuel filters dirty

Cooling system defective, test of the coolant pump see maintenance manual sect. 4.10.5.4.

Spark plugs defective

7. Sudden power loss at full throttle

ECU RPM sensor or its wiring defective, or injection nozzles or their wiring defective.

Switch over to emergency system, see section 3.15.

If this doesn't help check pistons and cylinders for seizing marks, see maintenance manual section 3.6.1 item 9.

Note: The ECU has a failure memory, which detects and stores failures of the system. This memory can only be checked by the manufacturer. For a check please send the ECU to DG Flugzeugbau or the engine manufacturer Solo or to a DG trained and approved service station.

Flight Manual DG-1000M

9 Supplements

Section		page
9.1	Introduction	9.2
9.2	List of inserted supplements	9.2
9.3	Special equipment for very small pilots	9.3

Flight Manual DG-1000M

9.1 Introduction

This section contains the appropriate supplements necessary to safely and efficiently operate the sailplane when equipped with various optional systems and equipment not provided with the standard sailplane.

9.2 List of inserted supplements

Date of insertion	Document No.	Title of the inserted supplement
October 2010	Section 9.3	Special equipment for very small pilots TN1000/17

9.3 Special equipment for very small pilots (TN1000/17)

To facilitate the operation of the glider by very small pilots 3 different items have been developed, which may be used separately or together.

9.3.1 Removable seat back for the front seat

- a) Installation of the seat back: Install the seat back with 2 screws M6x16 DIN965 4.8 BIC with cup washers 15 x M6 MS NI NR4157 to the threads which have been installed according to working instruction No. 1 for TN1000/17.
- b) The seat back may be adjusted further to the front by part Z198. Fix the part to the Velcro straps installed at the rear of the seat back.
- c) Remove the head cushion 8R80/2 from the holder on the rear instrument panel cover (fixed with Velcro). When removing the seat back reinstall the head cushion at the holder.

Install the head cushion see above to the Velcro straps installed at the front of the seat back. Instead of the approx. 70 mm (2.8 in.) thick head cushion a thinner head cushion approx. 40 mm (1.6 in.) thick may be used.

9.3.2 Airbrake-pushrod with additional handle in front cockpit

For pilots with arms too short to lock the airbrakes an airbrake-pushrod with additional handle part 5St69/2 may be instead in the front cockpit according to working instruction No. 2 for TN1000/17 instead of part 5St69.

This part may remain in the glider for normal operation.

9.3.3 Rudder pedal plates for rear cockpit Z197

Pilots with very short legs may clip rudder pedal plates part no. Z197 on to the rudder pedals. Plates may be installed and removed as often as desired.